

# TASCAM

TEAC Professional Division

9101439701

# DM-24

Digital Mixing Console

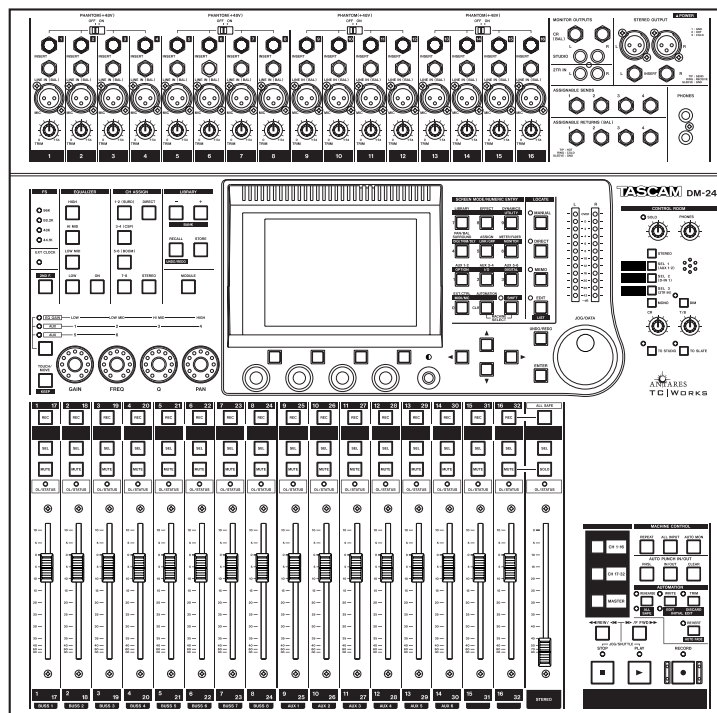

## OWNER'S MANUAL



**CAUTION**  
RISK OF ELECTRIC SHOCK  
DO NOT OPEN



**CAUTION:** TO REDUCE THE RISK OF ELECTRIC SHOCK, DO NOT REMOVE COVER (OR BACK). NO USER-SERVICEABLE PARTS INSIDE. REFER SERVICING TO QUALIFIED SERVICE PERSONNEL.



The lightning flash with arrowhead symbol, within an equilateral triangle, is intended to alert the user to the presence of uninsulated "dangerous voltage" within the product's enclosure that may be of sufficient magnitude to constitute a risk of electric shock to persons.



The exclamation point within an equilateral triangle is intended to alert the user to the presence of important operating and maintenance (servicing) instructions in the literature accompanying the appliance.

This appliance has a serial number located on the rear panel. Please record the model number and serial number and retain them for your records.  
Model number \_\_\_\_\_  
Serial number \_\_\_\_\_

**WARNING: TO PREVENT FIRE OR SHOCK HAZARD, DO NOT EXPOSE THIS APPLIANCE TO RAIN OR MOISTURE.**

# Important Safety Precautions

## IMPORTANT (for U.K. Customers)

### **DO NOT cut off the mains plug from this equipment.**

If the plug fitted is not suitable for the power points in your home or the cable is too short to reach a power point, then obtain an appropriate safety approved extension lead or consult your dealer.

If nonetheless the mains plug is cut off, remove the fuse and dispose of the plug immediately, to avoid a possible shock hazard by inadvertent connection to the mains supply.

If this product is not provided with a mains plug, or one has to be fitted, then follow the instructions given below:

**IMPORTANT:** The wires in this mains lead are coloured in accordance with the following code:

<b>GREEN-AND-YELLOW</b>	: EARTH
<b>BLUE</b>	: NEUTRAL
<b>BROWN</b>	: LIVE

**WARNING:** This apparatus must be earthen.

As the colours of the wires in the mains lead of this apparatus may not correspond with the coloured markings identifying the terminals in your plug proceed as follows:

The wire which is coloured GREEN-and-YELLOW must be connected to the terminal in the plug which is marked by the letter E or by the safety earth symbol  $\equiv$  or coloured GREEN or GREEN-and-YELLOW.

The wire which is coloured BLUE must be connected to the terminal which is marked with the letter N or coloured BLACK.

The wire which is coloured BROWN must be connected to the terminal which is marked with the letter L or coloured RED.

When replacing the fuse only a correctly rated approved type should be used and be sure to re-fit the fuse cover.

IF IN DOUBT — CONSULT A COMPETENT ELECTRICIAN.

For U.S.A

## TO THE USER

This equipment has been tested and found to comply with the limits for a Class A digital device, pursuant to Part 15 of the FCC Rules. These limits are designed to provide reasonable protection against harmful interference in a residential installation. This equipment generates, uses, and can radiate radio frequency energy and, if not installed and used in accordance with the instruction manual, may cause harmful interference to radio communications.

Operation of this equipment in a residential area is likely to cause harmful interference in which case the user will be required to correct the interference at his own expense.

### **CAUTION**

Changes or modifications to this equipment not expressly approved by TEAC CORPORATION for compliance could void the user's authority to operate this equipment.

### **For the consumers in Europe**

#### **WARNING**

This is a Class A product. In a domestic environment, this product may cause radio interference in which case the user may be required to take adequate measures.

### **Pour les utilisateurs en Europe**

#### **AVERTISSEMENT**

Il s'agit d'un produit de Classe A. Dans un environnement domestique, cet appareil peut provoquer des interférences radio, dans ce cas l'utilisateur peut être amené à prendre des mesures appropriées.

### **Für Kunden in Europa**

#### **Warnung**

Dies ist eine Einrichtung, welche die Funk-Entstörung nach Klasse A besitzt. Diese Einrichtung kann im Wohnbereich Funkstörungen verursachen ; in diesem Fall kann vom Betreiber verlangt werden, angemessene Maßnahmen durchzuführen und dafür aufzukommen.

# IMPORTANT SAFETY INSTRUCTIONS

## CAUTION:

- Read all of these Instructions.
- Save these Instructions for later use.
- Follow all Warnings and Instructions marked on the audio equipment.

- 1) Read Instructions** — All the safety and operating instructions should be read before the product is operated.
- 2) Retain Instructions** — The safety and operating instructions should be retained for future reference.
- 3) Heed Warnings** — All warnings on the product and in the operating instructions should be adhered to.
- 4) Follow Instructions** — All operating and use instructions should be followed.
- 5) Cleaning** — Unplug this product from the wall outlet before cleaning. Do not use liquid cleaners or aerosol cleaners. Use a damp cloth for cleaning.
- 6) Attachments** — Do not use attachments not recommended by the product manufacturer as they may cause hazards.
- 7) Water and Moisture** — Do not use this product near water — for example, near a bath tub, wash bowl, kitchen sink, or laundry tub; in a wet basement; or near a swimming pool; and the like.
- 8) Accessories** — Do not place this product on an unstable cart, stand, tripod, bracket, or table. The product may fall, causing serious injury to a child or adult, and serious damage to the product. Use only with a cart, stand, tripod, bracket, or table recommended by the manufacturer, or sold with the product. Any mounting of the product should follow the manufacturer's instructions, and should use a mounting accessory recommended by the manufacturer.
- 9)** A product and cart combination should be moved with care. Quick stops, excessive force, and uneven surfaces may cause the product and cart combination to overturn.



- 10) Ventilation** — Slots and openings in the cabinet are provided for ventilation and to ensure reliable operation of the product and to protect it from overheating, and these openings must not be blocked or covered. The openings should never be blocked by placing the product on a bed, sofa, rug, or other similar surface. This product should not be placed in a built-in installation such as a bookcase or rack unless proper ventilation is provided or the manufacturer's instructions have been adhered to.
- 11) Power Sources** — This product should be operated only from the type of power source indicated on the marking label. If you are not sure of the type of power supply to your home, consult your product dealer or local power company. For products intended to operate from battery power, or other sources, refer to the operating instructions.
- 12) Grounding or Polarization** — This product may be equipped with a polarized alternating-current line plug (a plug having one blade wider than the other). This plug will fit into the power outlet only one way. This is a safety feature. If you are unable to insert the plug fully into the outlet, try reversing the plug. If the plug should still fail to fit, contact your electrician to replace your obsolete outlet. Do not defeat the safety purpose of the polarized plug.
- 13) Power-Cord Protection** — Power-supply cords should be routed so that they are not likely to be walked on or pinched by items placed upon or against them, paying particular attention to cords at plugs, convenience receptacles, and the point where they exit from the product.
- 14) Outdoor Antenna Grounding** — If an outside antenna or cable system is connected to the product, be sure the antenna or cable system is grounded so as to provide some protection against voltage surges and built-up static charges. Article 810 of the National Electrical Code, ANSI/NFPA 70, provides information with regard to proper grounding of the mast and supporting structure, grounding of the lead-in wire to an antenna discharge unit, size of grounding conductors, location of antenna-discharge unit, connection to grounding electrodes, and requirements for the grounding electrode.

## “Note to CATV system installer:

This reminder is provided to call the CATV system installer's attention to Section 820-40 of the NEC which provides guidelines for proper grounding and, in particular, specifies that the cable ground shall be connected to the grounding system of the building, as close to the point of cable entry as practical.

Example of Antenna Grounding as per National Electrical Code, ANSI/NFPA 70

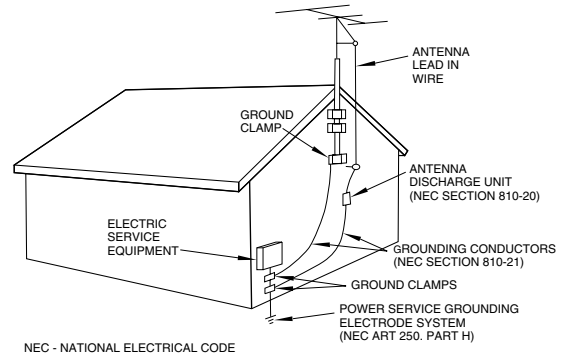

- 15) Lightning** — For added protection for this product during a lightning storm, or when it is left unattended and unused for long periods of time, unplug it from the wall outlet and disconnect the antenna or cable system. This will prevent damage to the product due to lightning and power-line surges.
- 16) Power Lines** — An outside antenna system should not be located in the vicinity of overhead power lines or other electric light or power circuits, or where it can fall into such power lines or circuits. When installing an outside antenna system, extreme care should be taken to keep from touching such power lines or circuits as contact with them might be fatal.
- 17) Overloading** — Do not overload wall outlets, extension cords, or integral convenience receptacles as this can result in risk of fire or electric shock.
- 18) Object and Liquid Entry** — Never push objects of any kind into this product through openings as they may touch dangerous voltage points or short-out parts that could result in a fire or electric shock. Never spill liquid of any kind on the product.
- 19) Servicing** — Do not attempt to service this product yourself as opening or removing covers may expose you to dangerous voltage or other hazards. Refer all servicing to qualified service personnel.
- 20) Damage Requiring Service** — Unplug this product from the wall outlet and refer servicing to qualified service personnel under the following conditions:
  - a) when the power-supply cord or plug is damaged.
  - b) if liquid has been spilled, or objects have fallen into the product.
  - c) if the product has been exposed to rain or water.
  - d) if the product does not operate normally by following the operating instructions. Adjust only those controls that are covered by the operating instructions as an improper adjustment of other controls may result in damage and will often require extensive work by a qualified technician to restore the product to its normal operation.
  - e) if the product has been dropped or damaged in any way.
  - f) when the product exhibits a distinct change in performance — this indicates a need for service.
- 21) Replacement Parts** — When replacement parts are required, be sure the service technician has used replacement parts specified by the manufacturer or have the same characteristics as the original part. Unauthorized substitutions may result in fire, electric shock, or other hazards.
- 22) Safety Check** — Upon completion of any service or repairs to this product, ask the service technician to perform safety checks to determine that the product is in proper operating condition.
- 23) Wall or Ceiling Mounting** — The product should be mounted to a wall or ceiling only as recommended by the manufacturer.
- 24) Heat** — The product should be situated away from heat sources such as radiators, heat registers, stoves, or other products (including amplifiers) that produce heat.

# Table of Contents

## 1 – Introduction

Features .....	8
Supplied accessories .....	9
About this manual .....	9
How this manual is arranged .....	9
Word clock issues .....	11

## 2 – User interface

Scope of controls .....	12
Global screens .....	12
Module screens .....	12
PODs .....	13
Fine value settings using the PODs .....	13
Other ways of changing values .....	14
Using the faders to change values .....	14
Soft keys .....	15
Soft key pull-up menus .....	15
Rotary encoders (ring LEDs) .....	15
Encoders used as EQ gain controls .....	16
Encoders used as EQ frequency controls .....	16
Encoders used as Q controls .....	16
Encoders used as pan controls .....	17
Encoders used as aux send controls .....	17
Fader layers .....	18
Machine control keys .....	18
Automation keys .....	18
Automation status .....	19

## 3 – System-wide options

OPTION screen .....	20
SETUP .....	20
UPPER BAR DISPLAY .....	20
LOCATE DISPLAY MODE .....	20
ENCODER OPERATION MODE .....	20
LIBRARY DIRECT KEY OPERATION .....	20
OL/STATUS LED TYPE .....	20
FADER SENSITIVITY .....	21
METER CALIBRATION .....	21
PREFERENCES .....	21
Fader Auto MODULE Select .....	21
Select MODULE Return .....	21
ST Link by SEL key .....	21
Balance Level CENTER: 0dB .....	21
SEL Key Follows Fader Layer Status .....	21
Meter Follows SEL key .....	22
Automation fader OFF .....	22
Cursor follows EQ Band Key .....	22
FLASH Info. ....	22
Version Info. ....	22
Battery Check .....	22
SOLO .....	22
MODE SELECT .....	22
SOLO LINK .....	22
SOLO TYPE .....	23
INPLACE SOLO DEFEAT .....	23
SYNC/TC .....	23
DTRS Remote Timecode .....	23
RS-422 IN Timecode .....	23
TRA Target link .....	23
Automation synchronization source .....	23
TC IN .....	23
MIDI IN MTC .....	24
INT. ....	24
INT. START TIME .....	24

FLY WHEEL (frames) .....	24
DIGITAL screens .....	24
CLOCK settings .....	24
High sampling frequency .....	25
Fs Status .....	25
D-IN MANUAL SETUP .....	25
WORD SYNC IN .....	25
TDIF interfaces .....	25
ADAT .....	25
AES3 .....	25
CASCADE MASTER .....	25
Word phase .....	25
Checking the clock sources .....	25
Out of range clock signals .....	26
The FORMAT screen .....	26
Type of DIGITAL IN connection .....	26
Other digital input parameters .....	26
Digital output .....	26
Multi I/O settings .....	26
Stereo out setup .....	26
SLOT screen .....	27

## 4 – Parts of the DM-24

Top surface .....	28
Analog module inputs .....	29
Other analog I/O .....	29
Module control section .....	30
Library section .....	30
Parameter control section .....	31
Monitoring section .....	32
Module faders and selection, etc. ....	33
Transport and automation control .....	33
Rear panel .....	34

## 5 – Setting up the I/O

Signal sources .....	36
Sixteen mic/line analog inputs .....	36
Three TDIF connectors .....	36
ADAT connector .....	36
DIGITAL IN 1 & 2 .....	36
Card slots .....	36
Assignable returns .....	36
Internal effectors .....	36
Output signals .....	37
Eight output busses .....	37
Six aux busses .....	37
Stereo master outputs .....	37
Direct outputs .....	37
Physical outputs .....	37
TDIF-1 connectors .....	37
ADAT OUT connector .....	37
Slot cards .....	37
Assignable sends .....	37
Digital outputs (x 2) .....	37
STEREO OUTPUTS (L, R) .....	37
Patching between input and return .....	37
Assigning inputs to channels .....	38
Input sources .....	38
Return modules .....	39
Digital inputs .....	39
Channel-to-buss assignments (global) .....	40
Master settings .....	40
AUX 1-2 .....	40
Channel-to-buss assignments by channel .....	41
Other module parameters .....	41

Output assignments .....	42	Source (pre/post and SOURCE) settings .....	56
Digital outputs .....	42	Setup .....	56
Assignable sends and returns .....	43	Linked aux sends .....	56
Master compressors .....	43	<b>Setup screen .....</b>	<b>57</b>
<b>6 – Hookup</b>		Channel source (CH SOURCE) .....	58
Analog connections .....	44	Gate switch (GATE SW) .....	58
MIC/LINE connections .....	44	Aux 1 and 2 source (AUX 1-2 SOURCE) .....	58
External dynamics processors and effectors .....	45	Compression insert (COMP INSERT) .....	58
Analog monitoring and mastering .....	45	Compressor switch (COMP SW) .....	58
Digital connections .....	46	Assignable insert position (ASSIGN INSERT) .....	58
DTRS recorder connections .....	46	Assignable insert switch (ASSIGN INS SW) .....	58
ADAT connections .....	47	Phase switch ( $\Phi$ ) .....	58
Digital inputs and outputs .....	47	Digital delay time (DELAY) .....	58
Synchronization and control connections .....	47	Digital delay units (UNIT) .....	59
Word sync clock connections .....	48	<b>Digital trim and delay (global) .....</b>	<b>59</b>
MIDI connections .....	48	Global digital trim .....	59
SMPTE/EBU timecode connections .....	48	Fader control .....	59
Meter unit .....	48	Setup .....	59
P2 connections .....	48	Global digital delay .....	59
		Unit .....	60
		Fader control .....	60
		Setup .....	60
		PRE/POST .....	60
		<b>Linked modules .....</b>	<b>60</b>
		Channels .....	60
		Master modules .....	60
		Linking and unlinking modules .....	60
		Stereo linking (global) .....	61
		Screens for linked modules .....	61
		Phase .....	61
		Pan .....	61
		Mono switch (MONO SW) .....	61
		<b>UTILITY copying .....</b>	<b>62</b>
		<b>8 – Dynamics processors</b>	
		Turning the processors on and off .....	63
		<b>DYNAMICS (input channels 1–16) .....</b>	<b>63</b>
		Selecting a gate or an expander .....	63
		“Master” settings .....	64
		GATE/EXPAND .....	64
		LINK L->R .....	64
		Trigger source .....	64
		Compressor .....	64
		Insert point .....	64
		LINK L->R .....	64
		Trigger source .....	64
		Soft keys (library) .....	64
		<b>DYNAMICS (channels 17–32) .....</b>	<b>64</b>
		<b>DYNAMICS (master channels) .....</b>	<b>65</b>
		No expander or gate .....	65
		Insert point .....	65
		Linking .....	65
		Assigning processors to master channels .....	65
		<b>Dynamics diagram .....</b>	<b>66</b>
		<b>Gates/expanders .....</b>	<b>66</b>
		Gate .....	66
		Threshold .....	66
		Range .....	66
		Hysteresis .....	66
		Gate attack time .....	66
		Gate hold time .....	66
		Gate decay time .....	66
		Expander .....	66
		Threshold .....	66
		Ratio .....	66
Output assignments .....	42		
Digital outputs .....	42		
Assignable sends and returns .....	43		
Master compressors .....	43		
<b>6 – Hookup</b>			
Analog connections .....	44		
MIC/LINE connections .....	44		
External dynamics processors and effectors .....	45		
Analog monitoring and mastering .....	45		
Digital connections .....	46		
DTRS recorder connections .....	46		
ADAT connections .....	47		
Digital inputs and outputs .....	47		
Synchronization and control connections .....	47		
Word sync clock connections .....	48		
MIDI connections .....	48		
SMPTE/EBU timecode connections .....	48		
Meter unit .....	48		
P2 connections .....	48		
<b>7 – Module operations</b>			
Selecting modules .....	49		
Common area indicators and controls .....	50		
Dynamics controls .....	50		
Gate/Expander .....	50		
Compressor .....	50		
Compressor insert point .....	50		
Dynamics meter .....	50		
Other common controls and displays .....	51		
Digital trim and pan .....	51		
Phase switch .....	51		
Assignable inserts .....	51		
Input/return assignments .....	51		
Meter .....	51		
EQ and buss assignments .....	51		
Fader section .....	51		
Mute and fader groups .....	51		
Digital trim control .....	51		
Pan control .....	51		
Balance controls for stereo linked pair .....	52		
Global pan .....	52		
Ganging .....	52		
Setup .....	52		
Dynamics screen .....	53		
Noise gate (GATE) .....	53		
Compressor .....	53		
Expander .....	53		
EQ .....	54		
On/off (all bands) .....	54		
Gain (all bands) .....	54		
Frequency range (all bands) .....	54		
Q (all bands) .....	54		
EQ band type .....	54		
High band .....	54		
High-mid band .....	54		
Low-mid band .....	55		
Low band .....	55		
EQ library .....	55		
Aux sends .....	55		
Aux sends (global) .....	55		
Fader control .....	56		
Setup .....	56		
Copy .....	56		

# Table of Contents

Attack .....	66	General parameters .....	83
Release .....	66	Program Change channels .....	83
<b>Compressors .....</b>	<b>67</b>	Program Change values .....	84
Threshold .....	67	General MIDI parameters .....	84
Compression ratio .....	67	MIDI OUT Active Sensing .....	84
Attack time .....	67	OUTPUT MTC when slaved .....	84
Release time .....	67	RESET (ffh) .....	84
Auto make-up .....	67	MIDI filtering .....	84
Output gain .....	67	Serial output .....	84
<b>Preset library entries .....</b>	<b>67</b>	Edit Frames .....	84
Compressors .....	67	Play Mode .....	85
Gates/Expanders .....	68	AUTO .....	85
<b>9 – Grouping</b>		DEFERRED .....	85
<b>Mute groups .....</b>	<b>69</b>	IMMEDIATE .....	85
Turning groups on and off .....	70	Cueing Mode .....	85
Copying mute settings to the faders .....	70	Locate Preroll .....	85
<b>Fader groups .....</b>	<b>70</b>	<b>Location memories .....</b>	<b>85</b>
Fader groups to mute groups .....	71	Selecting the location point display .....	85
Turning groups on and off .....	71	Storing a location memory “on the fly” .....	86
<b>Grouping layers .....</b>	<b>71</b>	Manually entering and editing a location	
<b>10 – Monitoring</b>		memory .....	86
<b>Control room monitoring .....</b>	<b>73</b>	Location to a location memory .....	86
Control room outputs .....	73	Viewing a list of location memories .....	87
Control room signal selection .....	73	Manual location .....	87
2-track input .....	74	Repeat play .....	87
<b>Studio monitoring .....</b>	<b>74</b>	Auto punch operations .....	87
Studio monitoring volume .....	75	ALL INPUT and AUTO MON .....	87
<b>Soloing .....</b>	<b>75</b>	<b>External control .....</b>	<b>87</b>
MODE SELECT .....	75	Moving between screens .....	88
SOLO LINK .....	75	<b>DTRS devices .....</b>	<b>88</b>
SOLO TYPE .....	75	DA-98HR .....	89
PFL .....	75	DIGITAL INPUT .....	89
AFL .....	75	INPUT PATCH .....	89
INPLACE SOLO .....	75	OUTPUT PATCH .....	89
Inplace solo defeat .....	76	INPUT MONITOR .....	89
SOLO level .....	76	TRACK DELAY .....	89
Turning soloing on and off .....	76	TIME MODE .....	89
<b>Dimming and talkback .....</b>	<b>76</b>	TC REC .....	89
<b>Slate settings .....</b>	<b>77</b>	TC Generator .....	89
Lineup oscillator .....	77	Machine Offset .....	89
<b>Meters and faders .....</b>	<b>77</b>	PUNCH IN/OUT .....	89
Master meters .....	78	DITHER .....	89
Channel faders .....	79	VARI SPEED .....	89
Meter and fader setup .....	79	CLOCK .....	89
Fader level .....	79	DTRS mixer .....	90
Meter ballistics (METER SETUP) .....	79	DA-78HR .....	91
<b>11 – Machine Control/Location</b>		DA-98 .....	91
<b>Selecting devices for control .....</b>	<b>80</b>	DA-38 .....	92
Deleting devices from the list .....	81	DA-88 .....	92
Auto-detection of devices .....	81	<b>MIDI controllers .....</b>	<b>93</b>
Selecting the control type for the devices .....	81	<b>MIDI faders .....</b>	<b>93</b>
STATE .....	81	<b>12 – MIDI</b>	
DEVICE .....	81	<b>Bulk dumps .....</b>	<b>95</b>
ID .....	81	Bulk transfer of data from the DM-24 .....	95
CHASE .....	81	Bulk transfer of data to the DM-24 .....	96
TRA .....	82	<b>Updating the system software .....</b>	<b>96</b>
REC .....	82	<b>Control Change messages to and from</b>	
Machine Control mapping memories .....	82	the DM-24 .....	96
To use a machine control mapping .....	83	<b>MIDI Implementation Chart .....</b>	<b>98</b>
Viewing the transport mappings .....	83	<b>13 – Library functions</b>	
Editing a mapping .....	83	Library concepts .....	99

<b>Managing library entries</b> .....	<b>99</b>	<b>Aux sends</b> .....	<b>115</b>
Storing active library entries .....	99	<b>Channel stereo linking</b> .....	<b>115</b>
Storing entries in a non-active library .....	100	<b>Grouping</b> .....	<b>116</b>
Loading entries from an active library .....	100	<b>Trim and delay</b> .....	<b>116</b>
Loading entries from a non-active library .....	100	<b>Libraries</b> .....	<b>116</b>
Library undo/redo .....	101	<b>Other screens</b> .....	<b>117</b>
Setting and editing titles .....	101		
<b>Libraries—snapshots</b> .....	<b>102</b>	<b>16 – Options</b>	
Protecting snapshot settings .....	102	Clock sources .....	118
I/O SEL / BUSS ASSIGN .....	102	<b>Cascade card</b> .....	<b>119</b>
GROUPING .....	102	Setting up the cascade .....	119
OTHER .....	102	Use of the cascade .....	119
Snapshot “neutral” setting .....	102	<b>Cascaded facilities</b> .....	<b>120</b>
<b>Libraries—effects</b> .....	<b>103</b>	Soloing and muting .....	120
<b>Libraries—dynamics processors</b> .....	<b>104</b>	Snapshots .....	120
Preset dynamics entries—compressors .....	104	Automation .....	120
Preset dynamics entries—gates .....	105	MIDI Control Change .....	120
<b>Libraries—EQ</b> .....	<b>105</b>	<b>Cascading and effects</b> .....	<b>120</b>
Preset EQ entries .....	106	High sampling frequency considerations .....	121
<b>14 – Surround operations</b>		<b>TDIF-1 card</b> .....	<b>121</b>
<b>Selecting a surround mode</b> .....	<b>107</b>	<b>ADAT card</b> .....	<b>121</b>
Monitoring surround patterns .....	107	<b>AES3 card</b> .....	<b>122</b>
Selecting a buss pattern .....	108	Input options .....	122
<b>Assigning modules</b> .....	<b>108</b>	Output options .....	122
<b>“Pan” controls</b> .....	<b>109</b>	<b>AD/DA card</b> .....	<b>123</b>
Global boom levels (5.1 only) .....	110	Timecode display .....	123
<b>15 – High sampling frequency</b>		<b>17 – Specifications</b>	
To select high sampling frequency .....	112	<b>Analog audio I/O</b> .....	<b>124</b>
Constraints on other devices .....	112	<b>Digital audio I/O</b> .....	<b>125</b>
<b>Channels, etc.</b> .....	<b>113</b>	<b>Miscellaneous I/O connections</b> .....	<b>125</b>
High sampling frequency I/O .....	114	<b>Equalization</b> .....	<b>126</b>
<b>Monitoring</b> .....	<b>115</b>	<b>System performance</b> .....	<b>126</b>
		<b>Physical characteristics</b> .....	<b>126</b>
		<b>Dimensional drawing</b> .....	<b>127</b>
		<b>Messages and troubleshooting</b> .....	<b>127</b>
		<b>Block diagram (normal sampling)</b>	

# 1 – Introduction

The DM-24 digital mixing console is designed to provide you with superlative audio quality in today's digital audio recording environment, as well as ease of use and flexibility to meet changing needs.

This *Reference Manual* is not intended to be read from cover to cover, but we do suggest that you make

yourself familiar with the contents of this section as well as the structure of this manual, so that you can find answers to questions when you need them.

If you learn a little about the key features and principles of operation now, before you start to use the DM-24 it will save you time and trouble later on.

---

## Features

---

The DM-24 includes many advanced features, including:

- the sixteen long-throw motorized “channel” faders are “layered”, allowing control of up to 32 mono inputs (which may be “ganged” in stereo pairs), eight buss sends and six aux sends in a compact package
- in addition to the sixteen faders mentioned above, one other dedicated motorized long-throw fader is used for the stereo out buss
- the TASCAM TDIF-1 digital audio format and other general digital audio formats such as ADAT, AES/EBU, SPDIF, as well as high-quality A/D and D/A conversion, are supported,
- Modular expansion slot facilities provide further flexibility
- sixteen integral high-quality microphone amplifiers, with switchable phantom powering and 24-bit A/D conversion
- the DM-24 is capable of accepting and transmitting digital audio data in 24-bit format, allowing it to be used with the HR series of TASCAM DTRS recorders as well as the MX2424 recorder
- internal processing is carried out at floating 32-bit resolution
- eight output busses and six auxiliary sends
- eight fader groups and eight mute groups
- grouping layers provide further flexibility in grouping arrangements
- all popular surround formats (2+2, 3+2, 5.1) as well as stereo, are supported for final mixdown
- expansion with another DM-24 console using an optional cascade slot card
- both 44.1 kHz and 48 kHz base sampling frequencies are supported, together with dual-frequency support (88.2kHz and 96kHz), with flexible clock configuration
- each of the 32 analog input channels is equipped with 4-band fully-parametric equalization and a dynamics processor
- the capability of acting as a remote controller for a wide variety of devices using the DTRS remote, P2 or MMC protocol
- synchronization to SMPTE/EBU timecode and MIDI timecode, and MIDI timecode generation facilities, allowing location of connected recorders, etc. and integration with the DTRS tape system
- full control room and studio monitoring facilities are provided, along with an integral talkback microphone and master bargraph meters
- graphical user interface, based on the successful TASCAM series of digital mixing consoles, and featuring a backlit LCD with a flexible POD-based user interface
- “ring encoders” give instant visual feedback of key EQ, pan and aux send settings
- integral Antares© Microphone Modeler technology, allowing the DM-24 to emulate the distinctive characteristics of any of a wide variety of classic or modern microphones, using any standard microphone
- integral t.c.electronics reverberation technology, providing full standard reverberation facilities within the DM-24
- flexible digital multi-effector providing many standard effects without the need for outboard equipment or connections
- library facilities for snapshot mix settings, frequently-used EQ settings, effect settings, dynamics processor settings, etc.
- MIDI control allows dynamic control of parameters through MIDI messages, so mix events can be recorded on MIDI for replay, as well as snapshot recall being linked to Program Change messages
- the DM-24 contains its own automation system, allowing full real-time control of almost all mix parameters with no need for connection to other units
- an optional meter bridge unit provides channel and master metering facilities through LED bargraph displays which are switchable in “layers”



---

## Supplied accessories

---

As well as the documentation supplied with the DM-24, you should also have packed with the unit:

- A power cord
- A warranty card
- A list of authorized TASCAM service stations

If any of these items is missing, contact your TASCAM distributor.

Retain the box and other packing material that came with the DM-24 in case you need to transport it in the future.

---

## About this manual

---

Please note the following typographical and other conventions used in this manual:

- Physical “push” controls of the DM-24 are referred to as “keys”.
- “Push” controls which are shown and used on the screen are referred to as “buttons”.
- The names of keys and other connectors and controls of the DM-24 are given in the following typeface: **DYNAMICS**.
- The names of on-screen buttons and other on-screen features, titles and prompts, etc. are given in the following typeface: LIBRARY DATA.

- The names of any physical keys, connectors and controls of other devices are given in the following typeface: **REMOTE IN**.

### **WARNING**

*“Warnings” give advice regarding a possible hazard to equipment or personnel.*

### **NOTE**

*“Notes” provide additional information which requires special attention.*

---

## How this manual is arranged

In addition to this manual, we also provide a *Quick Reference Guide*, which you can use to remind you of the quick ways in which common operations are carried out.

Even if you are familiar with the operation of mixers and digital mixers, and even if you never usually read instruction manuals, we suggest that you read the first few sections of this manual. They will provide useful background information for you as you use the DM-24.

The other sections of this manual are more in the nature of background reference, and contain information that you may not need for everyday working.

**1 – “Introduction” on page 8 :** This section. It provides an overview of the DM-24, its operational features, and the manual.

**2 – “User interface” on page 12 :** This section explains how to use the DM-24 controls in order how to access the different screens, change values of parameters and so on.

**3 – “System-wide options” on page 20 :**

There are a number of options available on the DM-24 which affect the whole operation of the unit. See

this section in order to understand the way in which these global settings will affect the way in which you use the unit,

**4 – “Parts of the DM-24” on page 28 :** This section introduces the different keys and controls of the DM-24. Since many of the keys have more than one function, which is determined by the software, it is impossible to give a full description of the use of each control in this section. A description of the top and rear panel connectors is also provided,

**5 – “Setting up the I/O” on page 36 :**

Because the DM-24 is essentially a “soft” product, many of the hardware features are not mapped to logical functions on a one-to-one basis. This section explains the different mapping and routing options available to you, and how to configure the DM-24 for your individual requirements.

**6 – “Hookup” on page 44 :** Explains how to connect the DM-24 to other equipment (analog and digital audio, control and timing connections, etc.).

**7 – “Module operations” on page 49 :** In many ways, this can be regarded as the most essential part of the manual. It explains how to carry out the

# 1 – Introduction—About this manual

operations that you would typically carry out with an analog console (EQ settings, assigning channels, making Aux sends, etc.).

## **8 – “Dynamics processors” on page 63 :**

The DM-24 contains flexible digital dynamics processors which can be used in a wide variety of ways, and these are treated in their own section here.

**9 – “Grouping” on page 69 :** The DM-24 allows channels to be grouped into fader and mute groups. This section explains how to set up and use these groups.

**10 – “Monitoring” on page 73 :** Using the DM-24 in a studio situation demands an understanding of the relationship between the different outputs and what is heard in the control room as well as the studio. This section covers these topics, as well as the flexible solo facilities provided with the DM-24.

**11 – “Machine Control/Location” on page 80 :** The DM-24 can act as a remote control unit for a wide variety of external devices, and provides MIDI timecode synchronization facilities. This section provides a guide to these facilities, as well as the way that the DM-24 can act as a location memory and recall unit for these external devices.

**12 – “MIDI” on page 95 :** MIDI devices can be used with Program Change and Control Change messages for remote control of the DM-24. In addition, settings can be stored for later recall over a MIDI connection using System Exclusive messages. This section gives details of these facilities.

It also explains the procedures to be carried out if the internal system software is to be upgraded.

**13 – “Library functions” on page 99 :** Various settings (effects, EQ settings, snapshots and

dynamics processors) can be stored for later use in internal libraries. Read this section in order to understand how to make the best of these facilities.

**14 – “Surround operations” on page 107 :** The DM-24 is capable of performing mixdown operations in various surround modes as well as stereo. This section explains how to connect and use the DM-24 for surround operations together with the way in which it can be used for successful surround mixing.

**15 – “High sampling frequency” on page 112 :** The DM-24 can be used in high sampling frequency modes (88.2k and 96k). This section describes the differences when the high sampling frequency is selected.

**16 – “Options” on page 118 :** This section provides you with a quick reference to the extra facilities available to enhance your DM-24. It also contains a list of the messages displayed by the DM-24. Even though the DM-24 is relatively simple to operate, and should prove almost error-free in everyday operation, you may need to refer to this section in order to correct an abnormal situation.

**17 – “Specifications” on page 124 :** The raw facts and figures concerning the DM-24. You may need to refer to this section to discover the compatibility of the DM-24 with other equipment.

There is also a list of messages which may be displayed by the DM-24. You may use this to help you understand what is going on when you see a message displayed on the screen.

**Index :** We try to make the index a useful place to look if you need help on a particular topic. Use the index first when searching for an answer.

## Word clock issues

The “word clock” in a digital audio system is the timing information that enables the digital audio samples in a system to be synchronized between the different devices. It is completely unconnected with timecode clocks, etc.

There must be one, and only one, word clock master device in a digital audio system. The DM-24 is capable of acting as a word clock master or as a slave.

### **WARNING**

*There should be one, and only one, word clock master in a setup. Multiple word clocks in a setup may result in noise, which can damage monitoring equipment (speakers and amplifiers).*

Check with the other equipment that you are using to see whether it can be a master or slave, and work out which device will be your word clock master. If the DM-24 is to be a word clock slave in your system, it can accept word clocks from the following sources:

- An external clock connected through the dedicated connector
- The TDIF-1 interfaces

- The integral ADAT interface
- Either of the two **DIGITAL IN** interfaces
- Either of the slots occupied by an optional digital interface card. In the case of an AES/EBU interface card, any of the four stereo signal pairs may be individually selectable as the word clock source.
- If two DM-24 units are being cascaded, the clock source on a cascaded DM-24 will always be the cascade master DM-24 unit. The master of the cascade chain can select its clock from any available source.

The clock can be at 44.1 kHz or 48 kHz or 88.1 kHz or 96 kHz with some variation possible for varispeed, etc. at  $\pm 6\%$ .

### **NOTE**

*When the DM-24 is linked to an external word clock, it can only use a base frequency clock. Even when many external devices are operating at high sampling frequencies, they output such a base frequency clock. If the external device does not do so, and only outputs a high sampling frequency clock, the DM-24 must be used as the word clock master for the system.*

## 2 – User interface

### Scope of controls

The DM-24 has three main types of control screen: system screens, which control parameters for the whole of the system, “global” control screens which

affect a certain parameter for a number of channels or modules at once, and the “module” control screens controlling all the parameters for one module.

### Global screens

As the name suggests, the “global” screens allow you to see all the parameters for many channels (the pre-post settings for Aux 3 in this example), and to edit them using the POD system as explained here (“PODs” on page 13).

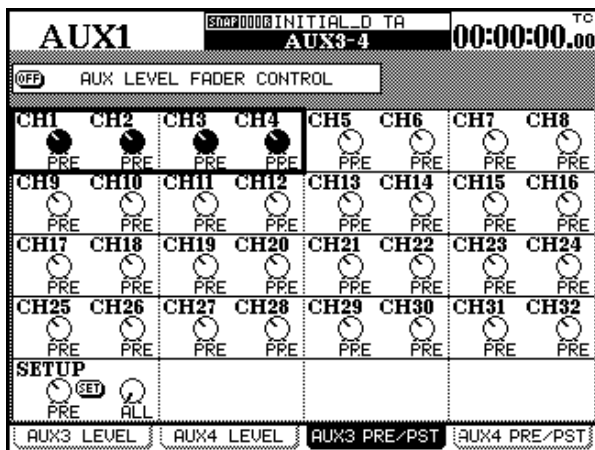

These global display screens are selected using the **SCREEN MODE** keys to the right of the display screen.

Sometimes a key will have two labels. The function described by the lower label (white on blue) is accessed by pressing the **SHIFT** key so that the **SHIFT** indicator is lit, and then pressing the appropriate key.

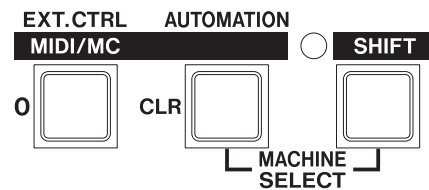

In this example, the **EXT. CTRL** key becomes the **MIDI/MC** key when the **SHIFT** indicator is lit.

The **SHIFT** key is a “smart” key. Pressing and releasing it within a short time (somewhat less than half a second) latches it on and off as shown by the indicator being lit.

Pressing and holding the key for more than about half a second and then releasing it will cause the indicator to go out when the key is released (non-latching).

While the **SHIFT** indicator is lit, the *shifted function* (the white on blue) is always active.

### Module screens

Alternatively, the screen can be used to show and set the parameters of one module (similar to a channel strip on a conventional console).

However, since the number of parameters and features available on the DM-24 is more than a single screen can display, four screens are available for each module, accessed through the soft keys (“Soft keys” on page 15).

To use a module:

- 1 Press the **MODULE** key situated to the left of the display.
- 2 Use the soft keys (“Soft keys” on page 15) to select a sub-screen (DYNAMICS, EQ, AUX or SETUP).
- 3 Press the **FADER LAYER** key containing the module whose parameters you want to edit.

- 4 Press the **SEL** key of the module you want to edit. The screen changes to show the settings for the selected module:

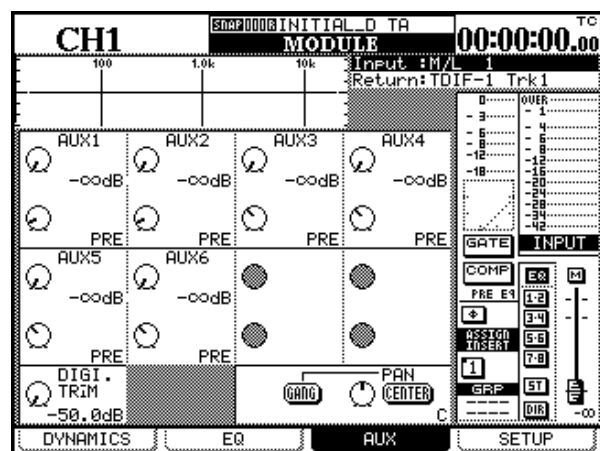

- 5 Use the cursor keys, the soft keys and the PODs to make changes to the module’s parameters. See below for details.**

### PODs

The DM-24 features four rotary controls immediately below the screen, called PODs.

These are used as “soft” controls to adjust parameters; that is, they have no fixed assignment to control any single parameter in the console, but are used to control a parameter which is currently highlighted on screen.

The POD controls have no end-stop, but are continuously moveable. The value of the parameter controlled by the POD is shown by the graphical on-screen representation of the control.

As part of the POD system, cursor keys are included, which move the cursor to the appropriate part of the screen.

In addition, the dial can usually be used to move the cursor around the screen. Usually when we mention that the cursor keys can be used for navigation, the dial can also be used, even when this is not explicitly stated.

Use the ▲ and ▼ keys or the dial to move the cursor row (shown by a blinking box surrounding the row) up and down. Sometimes in some global screens (as shown here) the box does not cover the full width of

a screen row, and the ◀ and ▶ keys or dial must be used to move the box within the row.

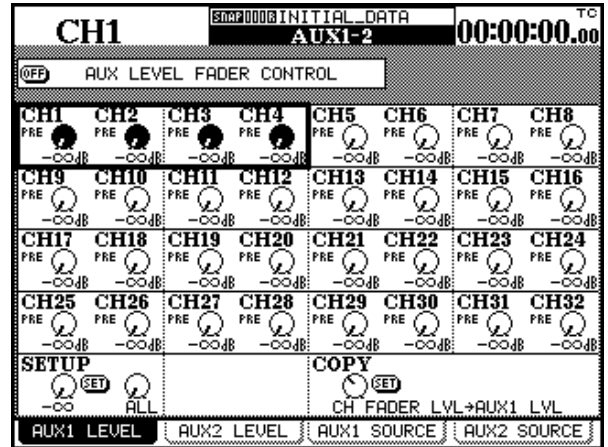

When a number of on-screen controls are highlighted by a box surrounding the row containing up to four on-screen knobs, the appropriate PODs are used to control the on-screen controls.

If the row also contains on-screen buttons, these are “pushed” by using the ◀ and ▶ keys or dial to navigate to the button in the row (if necessary), and then pressing the **ENTER** key.

### Fine value settings using the PODs

By pressing and holding the **2ND F.** key while turning a POD, the value set using the POD can be changed more precisely.

This feature is useful when the parameter being changed has many possible values (for example, the digital delay setting) which are first set using the default “coarse” setting, and then fine-tuned using the fine mode with the **2ND F.** key.

This feature can also be used with the rotary encoders (“Rotary encoders (ring LEDs)” on page 15) to

set values entered using these controls with more precision.

There is also an option setting which allows PODs and encoders to be used for fine setting of values without the use of the **2ND F.** key (“ENCODER OPERATION MODE” on page 20). If this is enabled, pressing the **2ND F.** key and turning the POD or encoder changes values in “coarse” or accelerated mode.

## 2 – User interface—Scope of controls

### Other ways of changing values

The **JOG/DATA** dial can also be used to change parameter values.

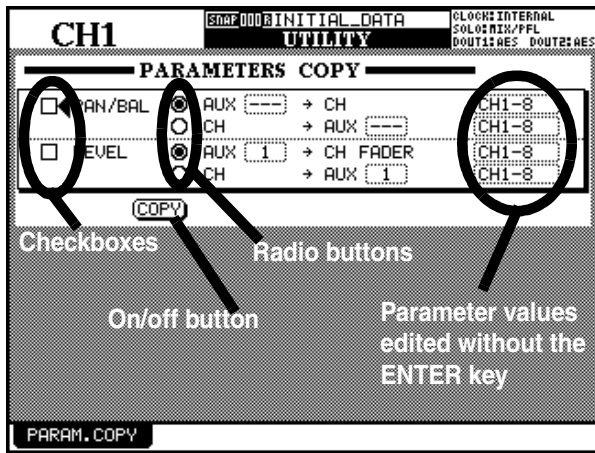

- 1 Use the cursor keys to move the cursor (sometimes shown by a blinking thick box surrounding the parameter to be changed, and sometimes by a  $\#$  symbol beside the parameter to be changed).
- 2 When the parameter to be changed is highlighted as described above, use the entry dial to set the value (it starts to flash), and the

**ENTER** key to confirm the value set with the dial.

Alternatively, if the parameter is an on-off switching button or a checkbox (a number of checkboxes can be checked individually), press the **ENTER** key when the cursor is next to the button or checkbox.

If the parameter is a “radio button” (one of a number of alternative options), simply highlight another radio button in the same group, and press the **ENTER** key to change the state of the buttons in the group.

#### NOTE

In some screens, (for example the module screens), the active area is marked by a flashing box. The dial is then used for navigation, rather than for setting values.

There are other screens, where the dial is chiefly, but not exclusively, used for navigation (e.g. the OPTION SETUP screen (“SETUP” on page 20)). If the dial is used for numerical data entry in such cases, it is necessary to press **ENTER** (the value flashes) before starting to edit the value with the dial, and **ENTER** once again after editing to confirm the value.

### Using the faders to change values

In the global screens, there is often a special on-screen button, allowing the setting of the values in the screen directly using the faders.

To enable this feature, turn the on-screen **FADER CONTROL** button to ON.

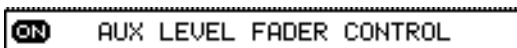

The name of this button is prefixed by the title of the screen (here it is an AUX LEVEL screen which is being edited).

When the button is turned on:

- The faders move to reflect the values set for the current parameter
- The fader layer key starts to flash (if it is a channel module layer and not the master layer—see “Fader layers” on page 18). This flashing key shows that the faders are not currently acting as channel faders

and that moving the faders will change the currently selected parameter, not the module’s signal level.

- Moving the fader of a channel changes the value of the current parameter.
- Using the POD to change the value of a channel’s parameter moves the corresponding fader if the layer is active. If the layer is not active, the fader will be moved to the new position when the layer is made active.

The status of the fader control setting is memorized between screens (and even when the DM-24 is turned off and on again). It is therefore possible for the faders to move when the screen is changed.

The layer continues flashing as long as the faders are not controlling the channel levels.

## 2 – User interface—Rotary encoders (ring LEDs)

### Soft keys

At the bottom of a display screen, there may be some “tabs” displayed, which lead to further related screens or pre-defined action.

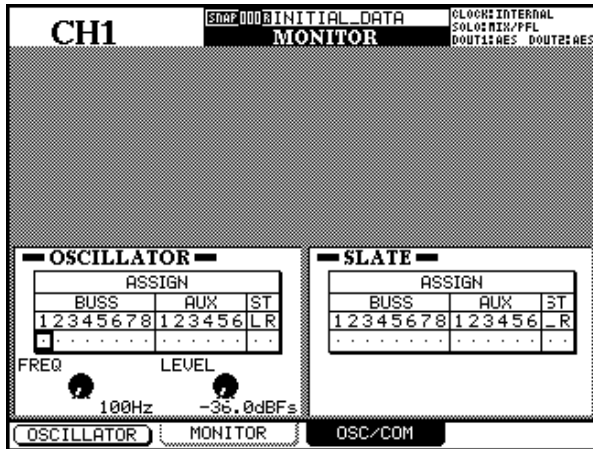

The four keys at the bottom of the screen, beside the PODs, are used as “soft keys” to jump to the screens shown on the “tabs”. In this example, the MONITOR and OSC/COM tabs are controlled by soft keys 2 and 3.

#### NOTE

It is also possible to jump to the different screens by repeated presses of the key which brings up the screen (in this case, the **MONITOR** key).

These keys are sometimes used to perform a unique “one-off” action, as shown in this screen, where the oscillator can be turned on and off using soft key 1.

### Soft key pull-up menus

In a few screens, for example, the library screens, where many soft keys are used for the “one-off” actions, a soft key (usually soft key 1) is used to bring up a small menu at the bottom of the screen:

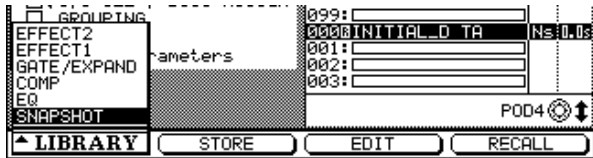

When such a menu pops up, either the dial or the POD corresponding to the soft key (usually POD 1) is used to select the desired option (which is highlighted in inverse video).

Use either the **ENTER** key or the soft key which was used to pull up the menu to make the selection from the menu.

### Rotary encoders (ring LEDs)

These controls allow you to set commonly-used parameters such as EQ parameters, pan and balance, and Aux send levels.

These are not dedicated controls, as the parameters which may be controlled using them are changed using selection keys, but their action is confined to fewer parameters than the POD controls.

Like the PODs, these controls are continuously moveable, and have no end-stop. Unlike the PODs, though, the parameters that they control may not necessarily be shown on screen. In order to gain an indication of the current value, the eleven LED indicators

arranged in a ring around the knob light to show the current value, as explained in the sections below.

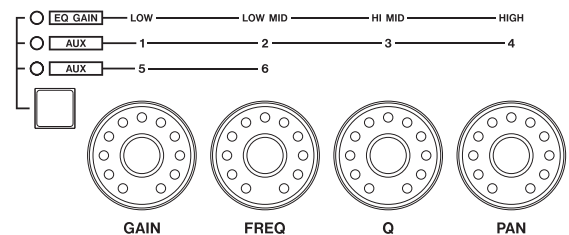

These encoders have three different functions:

- **EQ controls and pan controls** to control the EQ settings (gain, frequency and Q) as well as the current channel pan/balance of the currently active module. In this mode none of the encoder indicators (to the left of the encoders) is lit, and the band controlled is determined by the appropriate **EQUALIZER** key.

## 2 – User interface—Rotary encoders (ring LEDs)

- **EQ gain controls**, where the gain of the four EQ bands is adjusted using these encoders. The encoder **EQ GAIN** indicator is lit in this case.
- **AUX send level controls**, where either the encoder **AUX 1** through **4** indicators or the **AUX 5** and **6** indicators are lit (in the latter case, only the two leftmost encoders have any function).

See the appropriate section on module operations (“Module operations” on page 49) for full details of the parameters controlled here.

### NOTE

The option described in “Fine value settings using the PODs” on page 13 also affects the operation of these encoders when used in conjunction with the **2ND F.** key.

### Encoders used as EQ gain controls

When the encoders are used as EQ gain controls, a unity gain (neither cut nor boost) is represented by the sixth (center) LED being lit, and the two LEDs at the extreme clockwise and counterclockwise positions “half-lit” (*dimmed*).

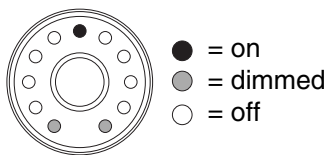

When the encoder is near the center position, but not quite there, the LED next to the center is lit, as well as the “end” LED on the appropriate side:

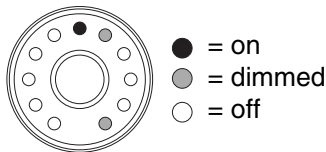

If the EQ band is set as a high-pass for low-pass filter or is used as a notch filter (depending on the band), all LEDs around the rotary encoder are off:

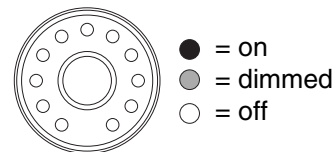

When the encoder is turned either clockwise or counterclockwise, to boost or cut the gain respectively, the end LEDs go out, and the LEDs on the appropriate side of the center light (the more the cut or boost, the more LEDs will light). “Half steps” are shown by dimmed LEDs at the end of the chain. The illustrations below show a relatively small amount of gain applied, and then a little more gain:

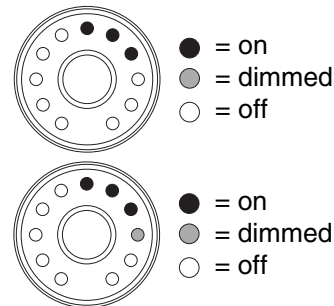

### Encoders used as EQ frequency controls

When the encoders are used to set the frequency controlled by an EQ band, only one or at most two LEDs are lit at any one time.

As the knob is turned clockwise, the ring LEDs light in turn, representing the position of the knob “pointer”. For greater accuracy, intermediate values

are shown by two LEDs being lit simultaneously, as in the illustration below:

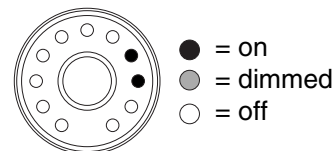

### Encoders used as Q controls

The Q of an EQ band refers to the width of the filter when it is in notch or peak mode (but not in shelf or



## 2 – User interface—Rotary encoders (ring LEDs)

filter mode). Low Q values affect a wide portion of the spectrum, as shown below:

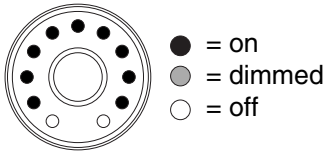

and high values affect a narrow frequency band:

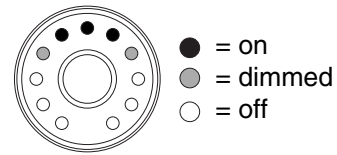

Note that “intermediate values” are shown on the encoders by dimmed LEDs, as above. The LED pattern in Q mode is always symmetrical about the upper center indicator.

### Encoders used as pan controls

When the encoders are used to make pan settings, the center pan position is represented in the same way as unity gain on the EQ gain controls:

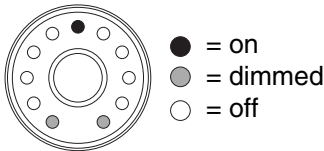

When the pan position is moved to either the left or the right of center, one (or two, to represent intermediate settings) LEDs light to show the current pan position.

The illustrations below show the pan position at the hard left position, and then at a position just right of hard left.

“Almost center” positions are shown in a similar way to the “almost unity” gain position (that is, the center LED is lit, along with the LED immediately next to it, with the end LED on that side being dimmed).

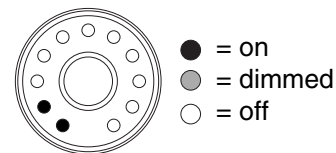
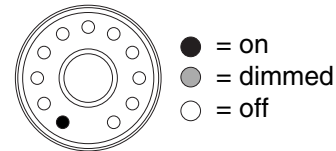
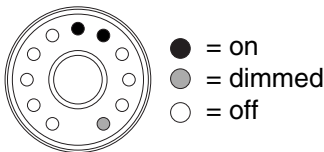

### Encoders used as aux send controls

When the encoders are used as aux send controls and the control is turned clockwise, the LEDs light up, following the “pointer” of the knob.

The number of LEDs lit depends on the aux send level relative to unity position (0.0dB).

Below this position, the LEDs light clockwise, with intermediate positions shown by dimmed LEDs:

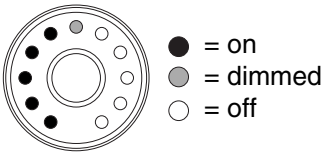
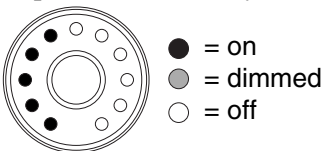

At the 0.0dB point, the LEDs representing values below this point are dimmed, and the “0” LED lights.

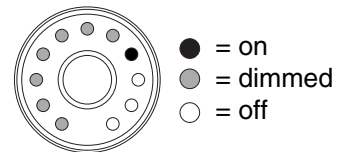

When aux sends are set above the 0.0dB level, the LEDs above the unity point light in sequence (intermediate positions shown by dimmed LEDs), with the LEDs below the unity point being dimmed. The diagram here shows a setting just below maximum (9.6dB):

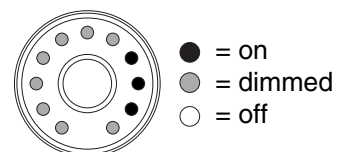

## 2 – User interface—Fader layers

When two aux channels are linked together, the encoders work in a slightly different way for the selected channel. The first encoder (**GAIN**) controls the pan for the first two aux sends (**1-2** or **5-6**) and the second (**FREQ**) controls the level for these sends. The third (**Q**) and fourth (**PAN**) control the pan and level respectively for aux sends **3-4** in the first **AUX**

encoder setting (they have no effect in the second **AUX** encoder setting).

The operation of the pan settings is as described for channel operations (“Encoders used as pan controls” on page 17).

---

### Fader layers

---

The DM-24 has sixteen physical “channel” faders and one master fader. However, it is capable of accepting more inputs than faders (up to 32 channels), and also has eight output busses and six aux sends, which are often controlled on conventional mixers using their own faders.

To allow the sixteen faders to control the different parts of the console, the faders are arranged in “layers”. The layers are arranged as follows (as shown above each fader on the console itself):

LAYER	1	2	3	4	5	6	7	8	9	10	11	12	13	14	15	16	M <sup>a</sup>
<b>1–16</b>	1	2	3	4	5	6	7	8	9	10	11	12	13	14	15	16	M
<b>17–32</b>	17	18	19	20	21	22	23	24	25	26	27	28	29	30	31	32	M
<b>MASTER</b>	B1	B2	B3	B4	B5	B6	B7	B8	A1	A2	A3	A4	A5	A6	—	—	M

a. Master fader

Use the **LAYER STATUS** keys located to the right of the master fader, to switch between the three fader layers. The selected key lights and the keys are of different colors, as shown in the table above, so that it is easy to see which layer is currently active, even from a distance.

These fader layers also affect the use of the module **REC** keys (used for arming the tracks of external control devices), the **SEL** keys, and the **MUTE** keys.

When the fader layer is selected, the faders move to show the current status of the layer.

---

### Machine control keys

---

As well as the keys controlling the DM-24 functions, there are also dedicated keys to control external devices connected to the DM-24.

Among these keys there are dedicated transport keys which allow basic transport control, as well as controls for auto punch and repeat control of external devices.

There are also **REC** keys at the top of each channel strip, which are used to arm tracks on a connected device.

See “Machine Control/Location” on page 80 for full details.

A strip of location keys to the right of the display mode keys controls the location facilities on the connected machine. When these keys are used for location, the **DISPLAY MODE** keys take on their **NUMERIC ENTRY** functions. The digits entered with these keys are labelled at the left of the keys.

These keys are also used to enter digits when naming or renaming library entries (“Setting and editing titles” on page 101).

---

### Automation keys

---

The DM-24 has self-contained automation facilities. The dedicated keys to control these functions are all colored purple for easy identification.

These keys are the **AUTOMATION** block by the transport controls, and the purple key near the rotary encoders.

There is a separate “shift” key to control the second function of some of the automation keys (and the

## 2 – User interface—Automation keys

undo/redo function of the library. This key is the **2ND F.** key (above and to the left of the rotary encoders). These second functions are labeled below the key in inverse lettering:

To use these second functions, press and hold the **2ND F.** key and press the key whose second function is to be used.

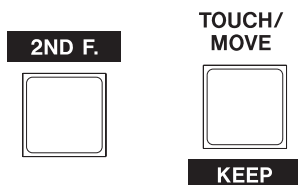

Press and hold this key and press this key to access this function (**KEEP**)

The **AUTOMATION UNDO** key is used in automation operations in order to undo any unwanted changes to automated mixes.

The operation of the automation facilities is explained in a separate manual.

---

### Automation status

As explained in the automation manual, the automation engine can be turned on or off in the main automation screen.

When the automation engine is enabled, the word **AUTO** appears at the top of the screen, together with any automation mode currently enabled.

## 3 – System-wide options

The DM-24 provides a number of options which control the overall functionality of the console.

These are accessed through the OPTION and DIGITAL screens.

Within these screens, you can (in the OPTION screen):

- Set up various interface preferences
- Set up the way in which soloing works

- Set up timecode preferences for synchronization with other units

and in the DIGITAL screen

- Set up the word sync clock
- Choose the digital input and output formats
- Define and make settings for the optional slot cards

These options are described in detail below:

### OPTION screen

To access the OPTION screen:

- 1 Press the **SHIFT** key so that the indicator is lit.
- 2 Press the **AUX 1-2/OPTION** key.

The screen changes to show the OPTION screen. There are four screens available using the soft keys immediately below the display: **SETUP**, **PREFERENCES**, **SOLO** and **SYNC/TC**.

### SETUP

The following options are available from this screen:

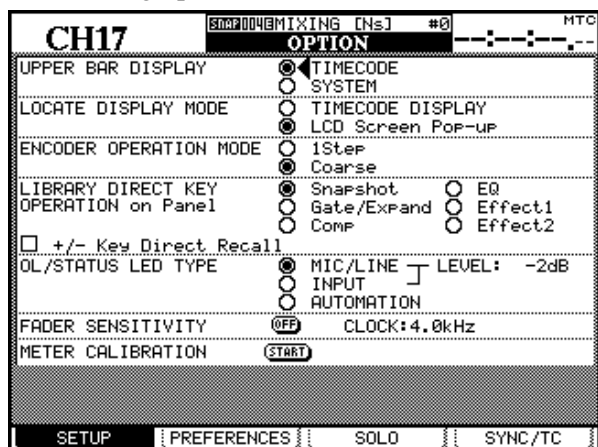

Use the **▲** and **▼** cursor keys (or dial) to move the cursor to the appropriate fields, and then press the **ENTER** key to change the value.

**UPPER BAR DISPLAY** This parameter has two options: **TIMECODE** and **SYSTEM**. When set to **TIMECODE**, the top right field of the display shows incoming timecode, and when set to **SYSTEM**, certain system parameters (clock source, solo mode, etc.) are displayed.



**LOCATE DISPLAY MODE** This parameter determines how a location entry will be shown on the display: in the timecode position (**TIMECODE DISPLAY**) or as a separate popup display in the center of the screen (**LCD Screen Pop-up**).

**ENCODER OPERATION MODE** When using the encoders (“Rotary encoders (ring LEDs)” on page 15), or the PODs, the parameter being edited may sometimes have too many values to allow easy setting using the encoder (for example, there are 127 different pan positions). Using the **1Step** setting, one “click” of the encoders corresponds to one step in the parameter values. Using the **Coarse** option allows the changing of the parameter values to be accelerated, with fewer clicks of the encoder.

Holding down the **2ND F.** key while turning the POD or encoder reverses the usual acceleration mode (if **1Step** is chosen, **2ND F.** + POD/encoder = accelerated, and if **Coarse** is chosen, **2ND F.** + POD/encoder = decelerated).

**LIBRARY DIRECT KEY OPERATION** This parameter controls the type of library accessed by the **RECALL** and **STORE**, and the **+** and **-** keys in the **LIBRARY** section to the left of the screen. There are six choices: **Snapshot** refers to the overall mixer settings, **Gate/Expand** to the dynamics processor settings for gate and expander effects, **Comp** to the dynamics processor settings for compression effects, **EQ** to the equalization setting library, and **Effect1** and **Effect2** to the first and second internal effector settings, respectively.

If the **+/- Key Direct** box is checked, this allows instant recall of a library entry selected using the **+** and **-** keys.

**OL/STATUS LED TYPE** The **OL/STATUS LED** indicators above each fader can serve one of two purposes: firstly, if either of the two “overload” options

## 3 – System-wide options—OPTION screen

(MIC/LINE or INPUT) is selected, they act as overload indicators when the input level exceeds the level set in the LEVEL field (OVER, 0, -2, -4, -6, -8, -10, -12, -18, -30 or -42 (dB)).

This status can be set for either the MIC/LINE inputs 1 through 16 or for the INPUT associated with the module, using the appropriate radio buttons.

Set the level for the overload lighting by moving to the value, pressing the **ENTER** key, turning the dial to set the value and pressing **ENTER** to confirm the value.

Otherwise, if the AUTOMATION option is selected, these indicators show the current automation status of the channels, as explained in the automation manual.

**FADER SENSITIVITY** This parameter allows you to specify the sensitivity of the faders, as used in the automation process.

The DM-24 touch sensing capabilities are dependent on the ambient humidity and environment. Depending on these factors, it may sometimes happen that faders which have been touched are not recognized as having been touched, or the faders are recognized as having been touched when they have not actually been touched.

The value of the sensitivity is set by default to 4.0k, but you may wish to set it to any of the following values: 1.0k, 1.5k, 2.0k, 2.5k, 3.0k, 3.5k, 4.0k (Hz). High values mean higher touch sensitivity.

While the FADER SENSITIVITY on-screen button is switched ON and this screen is visible, touching any of the faders with your fingers will illuminate the **STATUS/OL** indicator for as long as the fader is touched. This provides a very useful check for the sensitivity of the faders.

**METER CALIBRATION** Move the cursor to the START button and press **ENTER** to start the process of calibrating the DM-24 meters.

### WARNING

*You must turn down the headphone and control room monitor levels before starting this check, to avoid any possible damage to your ears and to the control room monitoring system.*

Press the **ENTER** key (or cancel the process using a cursor key). After the meter calibration process has finished (about 3 seconds), the message METER calibration finished appears as a popup message. You can then restore the control room and headphone levels.

## PREFERENCES

The following general working preference settings are available from this screen:

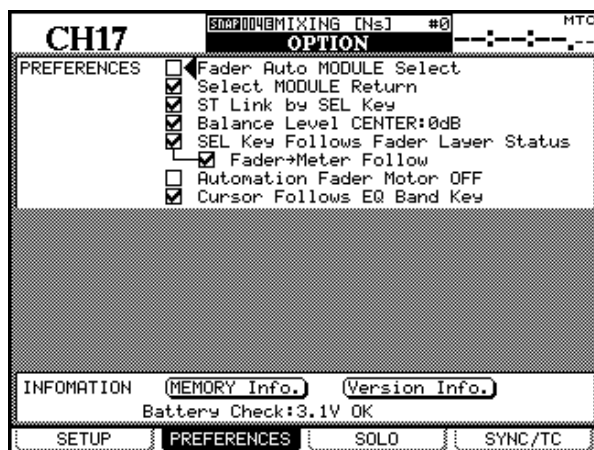

**Fader Auto MODULE Select** When enabled and a MODULE or DYNAMICS screen is shown, this option allows a module to be selected whenever its fader is touched, in addition to the usual method of pressing the **SEL** key. In other screens, when this option is enabled, the module shown at the top left of the screen changes when its fader is touched.

**Select MODULE Return** When checked, this option allows the MODULE screen of the appropriate module to appear if the **SEL** key of the module is pressed and held for about two seconds.

**ST Link by SEL key** When checked, this option allows the stereo linking of two adjacent modules (provided the left module of the pair is odd-numbered) by pressing and holding the **SEL** key of one module and pressing the **SEL** key of the other.

**Balance Level CENTER: 0dB** When two channels are linked together as a stereo pair, the pan controls change to a balance control, as mentioned earlier. In the center position, the level may either be set to 0dB (checked) or a 3dB cut (unchecked).

**SEL Key Follows Fader Layer Status** allows the setup of the automatic linking of the selected channel to the selected meter layer.

When this option is selected, if a channel is selected, the fader layer is changed, and then the fader layer is changed back again, the originally-selected channel is automatically selected.

## 3 – System-wide options—OPTION screen

For example, if this option is active, and **SEL 2** key is lit with fader layer 1-16 active, fader layer 17-32 is then selected, **SEL** key 3 (channel 19) is selected, and then fader layer 1-16 is then re-selected, **SEL** key 2 will be active.

If the option is not active, any **SEL** key which is lit remains lit when the fader layer is changed. For example, if this option is not selected, and **SEL** key 2 is lit with fader layer 1-16 active, and fader layer 17-24 is then selected, **SEL** key 2 will still be lit (that is, channel 18).

**Meter Follows SEL key** When this option is checked, the meter layer automatically changes when the appropriate **SEL** key is pressed (see “Meters and faders” on page 77). The modes are as follows:

Fader layer	SEL keys	Meter layer
CH 1-16	CH 1-16	CH 1-24
CH 17-32	CH 17-24	CH 1-24
	CH 25-32	MASTER/CH 25-32
MASTER	Buss 1-8/Aux1-6/Stereo	MASTER/CH 25-32

**Automation fader OFF** When this option is active (checked), in automation mode, when the automated mix is being read (played back), the faders do not move.

**Cursor follows EQ Band Key** When the option is enabled and modules are being edited, and any of the EQ band keys (**HI**, **HI MID**, **LOW MID** or **LOW**) is pressed, the box cursor surrounding the active on-screen controls will move to highlight the active band.

### SOLO

The solo modes on the DM-24 can be set up in a number of different ways using this screen:

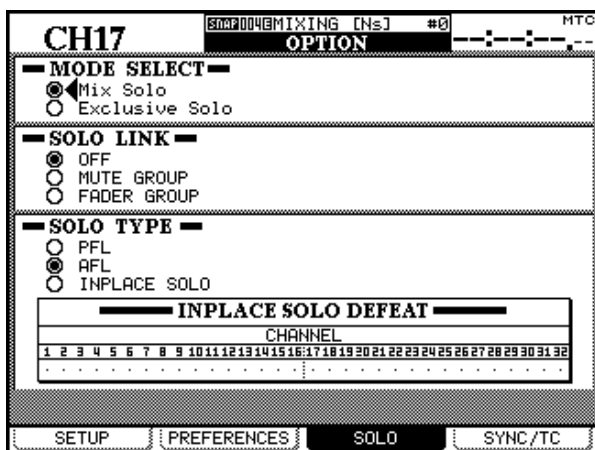

**FLASH Info.** This on-screen button allows you to see how many times the flash memory used for storing library entries, etc. has been used (written to). Moving the cursor to this on-screen button and pressing **ENTER** brings up a pop-up panel showing the number of times that the flash memory locations have been used. Pressing **ENTER** again allows you to view the automation memory area usage. Dismiss this pop-up by pressing **ENTER** once more.

If any flash memory location has been written to too many times in the life of the unit, a popup message will automatically appear to alert you of this fact. You should then contact your TASCAM dealer for service.

**Version Info.** For service, etc. it is useful to know the software version numbers of the different components. Moving the cursor to this on-screen button and pressing **ENTER** brings up a pop-up panel with the software version numbers of the different components (including the internal effector units). Press **ENTER** to dismiss this panel.

**Battery Check** This is a “read-only” display. It shows the current voltage and the status of the DM-24’s internal battery.

If the battery voltage falls below a certain level, or is reported as being above a certain level, this display blinks, and the screen shows Can’t Save System Data, together with the out-of-range voltage.

Consult your TASCAM distributor if you see this message.

**MODE SELECT** Either Mix Solo or Exclusive Solo can be selected here. The Mix Solo mode allows a number of channels (that is, all whose **MUTE** keys are lit in solo mode) to have their outputs added together to the solo mix. The Exclusive Solo mode only allows one channel (the one whose **MUTE** key was pressed last) to be soloed at one time.

**SOLO LINK** This option allows the fader and mute groups to be used with the solo function. This is explained more fully in the solo part of the section describing monitoring (see “SOLO LINK” on page 75). Briefly, if one of the group options (MUTE GROUP or FADER GROUP) is enabled, selecting a group master module solos or unsolos the whole of the group. If a group slave module is selected, the solo status of only that slave module is affected.

**SOLO TYPE** There are three options that may be selected here: PFL (pre-fader listen), AFL (after- or post-fader listen) and INPLACE SOLO. Again, these are explained in more detail in the solo section, but briefly; the PFL option provides a way of listening to the signal before it is sent through the panpot and fader. The stereo outputs are unaffected (soloing is only done through the **CR** and **STUDIO** monitor outputs) An AFL selection will output the post-fader signal from the selected channels through the monitoring system. By contrast, soloing a channel in Inplace Solo mode monitors the soloed signal(s) via the stereo outputs while all the other signals are cut from the stereo outputs.

**INPLACE SOLO DEFEAT** This option is a defeat option to prevent channels selected in this way from being muted when other channels are soloed. It can be used with a pair of effect returns, for instance, so that these effect returns will always be added in the inplace mix, together with those other channels selected for inplace soloing. Inplace soloing will output the soloed channel(s) from the stereo outputs, and cut all other channels. Use the cursor keys (or channel **SEL** key) to highlight a channel, and the **ENTER** key to change the status of the INPLACE SOLO DEFEAT setting.

Alternatively, use the **SEL** keys of the modules for direct selection and de-selection of the channels (use **ENTER** to make the setting).

### SYNC/TC

The following settings affect the timecode and synchronization settings (as can be selected for display on the top right of the screen, used for automation purposes as well as for location, etc.):

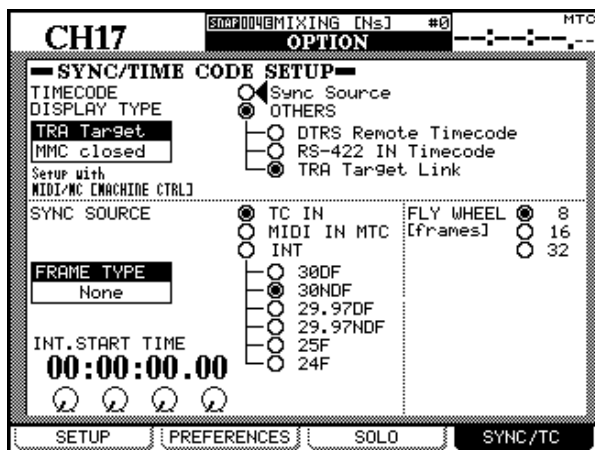

The screen is split into two parts: the top part allows the selection of a timecode source for display. This displayed timecode may be the source used for automation synchronization (Sync Source) or another source of timecode (OTHERS).

If Sync Source is selected, the source selected in the lower part of the screen to determine the automation synchronization source is displayed.

The following options are available for the display of incoming timecode:

**DTRS Remote Timecode** This is the timecode embedded in the **REMOTE/SYNC** output from a DTRS unit. The actual format and the relationship of this to the ABS time on the DTRS unit depends on the setup of the DTRS unit. If the ABS time is used as the timing source on the DTRS unit, ABS is shown

at the top right of the DM-24 display (above the timecode value). If timecode is selected as the timing source on the DTRS unit, TC is shown on the top right of the display.

#### NOTE

A DTRS unit connected to the DM-24 through a card inserted in slot 1 or 2 cannot be used as a timecode display source in this way.

**RS-422 IN Timecode** This refers to any timecode received through the RS-422. If this option is selected, TC is shown on the top right of the DM-24 display.

**TRA Target link** This refers to the timecode from the currently selected transport target (as set up in the MIDI/MC settings

Either TC or DTRS is shown on the top right of the screen if the transport target is a DTRS unit (as explained above), ABS if an ADAT is selected, MTC if the transport target is a closed MMC loop, and INT if the internal generator is selected as the transport target.

If the transport target is a MMC closed loop device, this (MMC Closed) is highlighted on screen.

#### Automation synchronization source

Choose from the following options to select the automation synchronization timecode source:

**TC IN** This refers to the analog linear timecode signal received at the **TC IN** jack. If this option is selected, TC is shown on the top right of the DM-24 display.

## 3 – System-wide options—DIGITAL screens

**MIDI IN MTC** This refers to any MIDI Timecode received at the **MIDI IN** jack. If this option is selected, MTC is shown on the top right of the DM-24 display.

**INT.** This refers to the DM-24's own internal (MIDI Timecode) generator.

### NOTE

*The internal timecode generator is not functional in this release of the DM-24 software. It will be implemented in a future release, and appropriate documentation concerning its use will be provided at that time.*

If the internal generator is chosen, the frame type can be selected from the following list: 30DF (30 fps drop-frame), 30NDF (30 fps non-drop), 29.97DF (29.97 fps drop-frame), 29.97NDF (29.97 fps non-drop), 25 (25 fps) and 24 (24fps). If this option is selected, INT is shown on the top right of the DM-24 display.

If the internal frame type is changed, then an automatic calculation is performed to convert the old frame type as accurately as possible to the new frame rate. For instance, if the frame type is 24 fps and the

current frame position is set to 12 (that is, halfway through a second), if the frame type is changed to 30 fps the frame position will be set to 15 (again, half-way through a second).

### NOTE

*When external timecode sources are used, the frame type is automatically recognized.*

**INT. START TIME** If the internal generator is selected as the timecode source, then the PODs are used to set the generator start time. Move the cursor so that the time is surrounded by an on-screen box, and then use the four PODs to set the hours, minutes, seconds and frames of the generator start time.

**FLY WHEEL (frames)** If an external timecode source is selected, then it is possible to compensate for loss of incoming signal, allowing the DM-24 to “flywheel” for a set number of frames before it reports the loss of incoming timecode. The values available here are 8, 16 and 32 frames (the length of a frame depends on the frame type being received).

## DIGITAL screens

The DIGITAL screens contain a number of different parameters affecting the digital audio operation of the DM-24.

There are three screens: the CLOCK screen, where the digital clock source is selected, the FORMAT screen, which provides facilities for controlling the format of digital data transmitted from and received by the

DM-24, and the SLOT screen, to control any optional cards fitted in the slots.

### NOTE

*There should be one, and only one, word clock source in a digital audio setup. Multiple word clocks in a setup may result in noise which can damage monitoring equipment (speakers and amplifiers).*

## CLOCK settings

This screen allows the viewing and selection of digital audio clocks from devices connected to the DM-24.

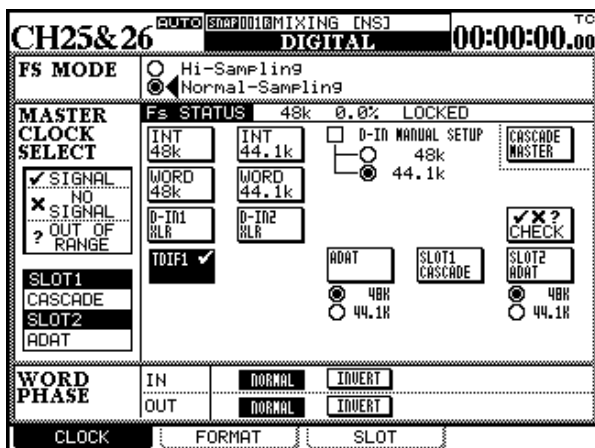

Use the cursor keys or dial to move around the screen, and the **ENTER** key to make selections.

Depending on the current assignments, the screen may change a little from that shown here. For example, if ADAT has not been selected as a return source, then it will not be shown in the appropriate position. If slot cards are not fitted, they will not appear on this screen, but if they are fitted, the SLOT fields to the left of the screen are filled, and show the slot cards currently fitted.

The condition of a master clock status is shown using symbols.

If the right clock is not available, or if the clock is out of the permissible limits, an appropriate symbol (cross or question mark) is shown.



A popup appears with an unlocked indication and an error message. If this happens, correct the clock source, and press the **ENTER** key to dismiss the popup.

When a clock source is selected, the clock indicators to the left of the console change to show the current clock frequency and the **EXT CLOCK** indicator lights if an external clock has been selected as the clock source.

**High sampling frequency** To select high sampling frequency mode, select Hi-Sampling, and press **ENTER**.

When the DM-24 changes to high sampling frequency, a popup message is shown on screen, telling you to turn off the DM-24 and turn it on again, to enter high sampling frequency mode.

### NOTE

*Remember to turn down the monitor value, etc. to avoid “thumps” which may damage equipment when turning the DM-24 on and off.*

The clock source screen changes in the case of high sampling frequency being selected.

### NOTE

*Many other display screens will change if high sampling frequency is selected. These differences are described in a separate chapter (“High sampling frequency” on page 112).*

**Fs Status** This shows the current sampling frequency status (base frequency, deviation from the nominal value, and the locked/unlocked status).

```
Fs STATUS 48k +0.0% LOCKED
```

Select the appropriate clock source. In the case of the internal clocks, the frequency may be chosen as either 44.1 kHz or 48 kHz. In most other cases, the frequency is pre-determined.

There are one or two other points to be borne in mind when making these settings.

### Checking the clock sources

To give details of all possible sources, move the cursor to the on-screen **CHECK** button, and press **ENTER**.

A popup message appears. Use the **ENTER** key to continue with the check (cancel using any of the cursor keys).

**D-IN MANUAL SETUP** A manual selection may be made in the case of one of the digital inputs (**D-IN**) being selected as a clock source with sampling frequency conversion. Select the appropriate destination frequency here.

Whether the RCA or XLR connector is used as the clock source is selected in the I/O screens (“Digital inputs” on page 39), not here.

**WORD SYNC IN** Since the frequency information of any signal received at the **WORD SYNC IN** connector is not used by the DM-24, if this source is to be selected as the word sync source for the DM-24, the sampling frequency must be explicitly selected.

**TDIF interfaces** In the case of the TDIF-1 interfaces card), the device attached to the card source is shown as either a DA-88 (DA-88 DTRS recorder) or OTHER (another type of recorder connected through the TDIF-1 interface). If the indicator shows DA88, then I/O data is truncated to 16 bits, otherwise I/O is carried out at 24 bits.

**ADAT** In the case of an ADAT “lightpipe” interface card, the INT setting, allowing the ADAT to act as the clock master, is always selected.

**AES3** In the case of an AES/EBU interface card, there are four different sources (the four AES/EBU inputs<sup>1</sup>) which may be selected as the word clock source for the DM-24.

**CASCADE MASTER** If the DM-24 has been set up as a cascade slave (using the **DIGITAL SLOT** screen), then this cascade master option is automatically selected, and this setting cannot be changed (the master is free, of course, to accept its clock from anywhere).

**Word phase** The phase of the word sync signal can be inverted independently for input and output relative to normal. Use the phase correction facilities to match word clocks from different equipment.

1. This changes to two inputs when high frequency sampling is selected.

The DM-24 mutes, and a panel appears with details of all possible clock sources. Press **ENTER** once again to dismiss this panel.

## 3 – System-wide options—DIGITAL screens

### Out of range clock signals

When setting the clock, the sampling frequency received can be  $\pm 6\%$  of the stated nominal value. When in use, the frequency can be  $\pm 7\%$  of the stated value. This allows a digital device which has a varispeed feature to be used as the word clock source for the DM-24.

If the selected clock source goes out of range, the DM-24 mutes, the currently-selected clock indicator flashes, and a message appears on the display.

The DM-24 reports the out-of-range clock frequency at a range of  $\pm 9.9\%$  relative to the stated frequency, but mutes at 7.0% or over.

Press the **ENTER** key to dismiss the popup message, change to the **CLOCK** screen, and correct the error condition (by selecting another clock source, or by re-selecting the clock if it has come back into range).

### The FORMAT screen

This screen allows you to see and work with the digital audio inputs and outputs connected to the DM-24.

**CH1** SCHEDULED INITIAL D TA **DIGITAL** 00:00:00.00

**DIGITAL I/O SETUP**

DIGITAL1-2 Tx/Rx MODE: NORMAL

DIGITAL IN1 XLR	DIGITAL IN2 XLR
Fs CONVERT: OFF	Fs CONVERT: OFF
<input type="checkbox"/> MUTE DEFEAT (DETAIL)	<input type="checkbox"/> MUTE DEFEAT (DETAIL)

DIGITAL OUT1 STEREO	DIGITAL OUT2 STEREO
FORMAT: AES/EBU (DETAIL)	FORMAT: AES/EBU (DETAIL)

MULTI I/O	SOURCE	INPUT WORD LENGTH	Detail
TDIF 1	BUSS1-8	16bit	(DETAIL)
TDIF 2	BUSS1-8	16bit	(DETAIL)
TDIF 3	AUX1-4	16bit	(DETAIL)

**STEREO OUT SETUP**

WORD LENGTH: 16bit (Noise shaped)

CLOCK    **FORMAT**    SLOT

The first part of this screen affects the digital inputs. Note that the I/O screen is used to determine whether the XLR connector or RCA pin jack is used for each of these inputs.

**Type of DIGITAL IN connection** Typically, these connectors will be used for base frequency digital audio (44.1 k or 48 k). This is shown as **NORMAL** on the display. However, if the DM-24 is in high sampling frequency mode, these inputs may be used for high sampling frequency inputs. There are two ways in which they can be used for high sampling frequency; **DUAL-LINE** (where one AES/EBU cable is used to transmit one channel of high sampling frequency audio, hence two lines are needed for a stereo pair) and **HIGH-SPEED** where the audio is transmitted at twice the usual speed, where one AES/EBU cable is used to transmit a pair of high sampling frequency signals at high speed.

Use the cursor, dial and **ENTER** key to set this value. If the DM-24 is set to an incompatible sampling frequency, a popup message appears.

**Other digital input parameters** At normal base sampling frequencies, the DM-24 is capable of performing sampling frequency conversion on the incoming data. This can be turned on or off individually using the on-screen **Fs CONVERT** buttons.

The **MUTE DEFEAT** checkbox allows the DM-24 to ignore a status bit in some implementations of digital audio, which are otherwise satisfactory. If this is unchecked, when this audio is received, the input may be muted and the following messages may be displayed on screen: Not Audio data Digital In1 (byte 0, bit 1=1 of the channel status) or Source Fs unlocked (byte 0, bit5=1).

Details of the digital audio data can be obtained from a popup produced by pressing the **DETAIL** button. Such information includes the format, type, emphasis status, etc.

**Digital output** The assignments for the two digital outputs are made using the I/O screen. The format can be changed between AES/EBU and SPDIF (the SPDIF option is meaningful at base sampling frequencies only) and details of the data can be obtained from a popup produced by pressing the **DETAIL** button. Such information includes the format, contents, emphasis status, word length, etc.

**Multi I/O settings** These assignments are made in the I/O screen, and cannot be changed. However, the word length for each of the TDIF groups can be set (either 16bit, 20bit or 24bit) and the details can be viewed (**DETAIL** button). These details include TX/RX mode, sampling frequency, word length and emphasis status, etc.

**Stereo out setup** This allows the choice of the word length output from the stereo out as being either 24-bit data, 20-bit with noise shaping, or 16-bit with noise shaping.

## 3 – System-wide options—DIGITAL screens

### SLOT screen

On the slot screen, the different optional interface cards that can be fitted to the DM-24 are automatically detected and the options can be set. These are described separately in “Options” on page 118.

If slot cards have been fitted, they are shown on this screen, as in the example below.

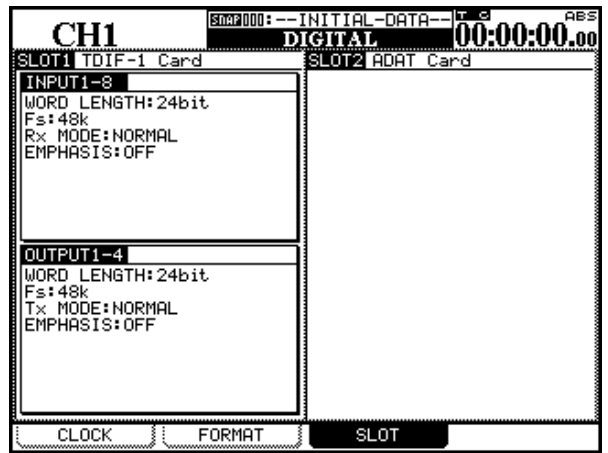

# 4 – Parts of the DM-24

This section is divided into what we hope is a functional and logical order to help locate and use the controls.

This section is not a complete guide to the functions of the DM-24—treat it more as a “road-map” than a guidebook.

## Top surface

The top surface of the DM-24 may be conveniently divided into the following sections:

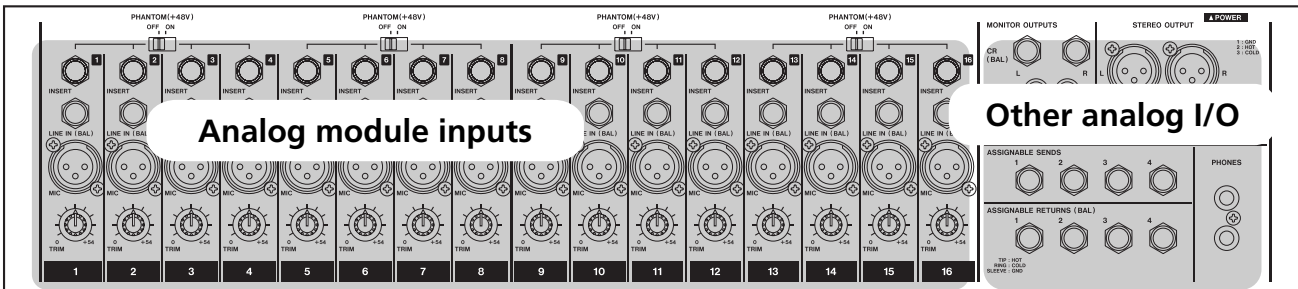

## Library section

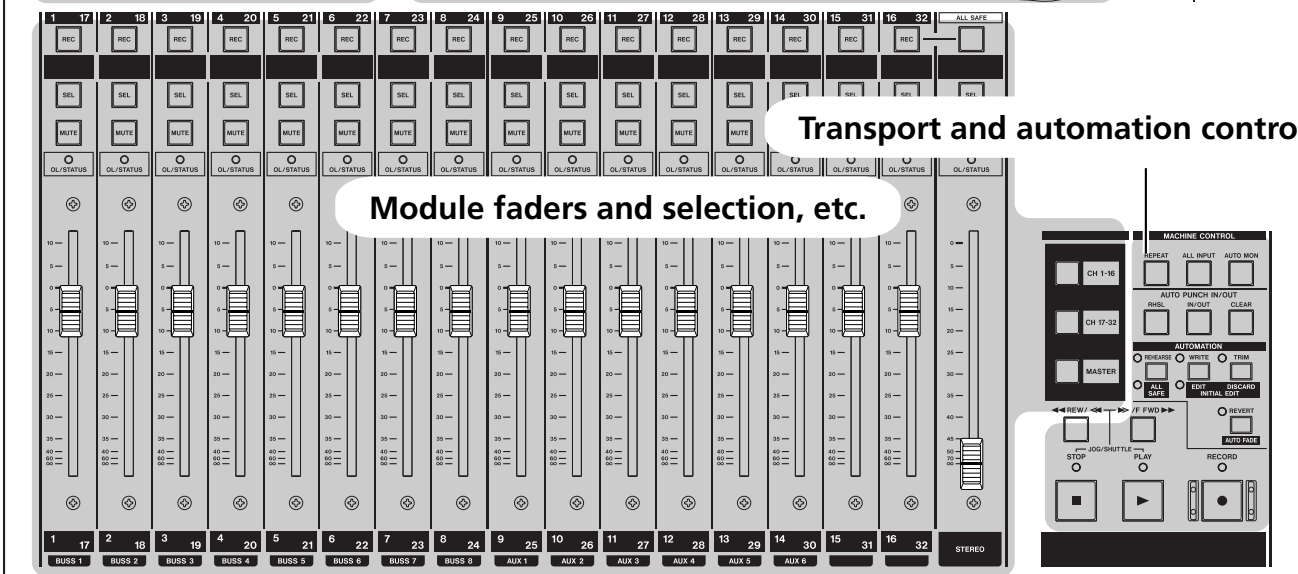
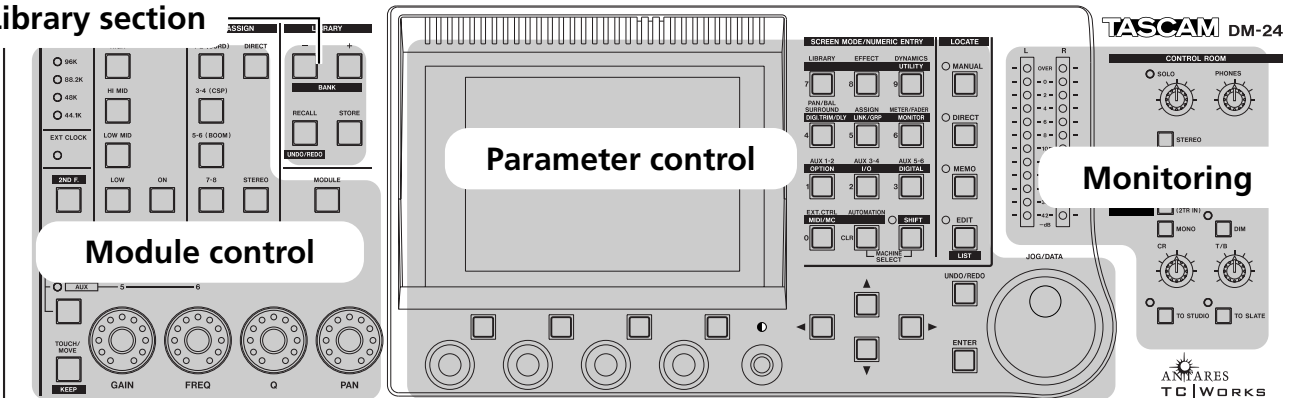

## Analog module inputs

These inputs typically feed the first sixteen input channels, but may be assigned in other ways as explained in “Setting up the I/O” on page 36.

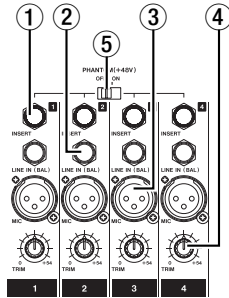

- ① **INSERT** These TRS 1/4” connectors are used to provide a post-**TRIM** insert (send at  $-2\text{dBu}$ ), and the return ( $-2\text{dBu}$ ) occurring just pre-AD convertor.
- ② **LINE IN (BAL)** These balanced 1/4” jacks accept analog inputs at a nominal  $+4\text{dBu}$  input level, adjustable with the **TRIM** controls.
- ③ **MIC** These XLR connectors accept analog inputs for balanced microphones. Phantom power is available (switchable in groups of 4 inputs).  
The input level is adjustable with the **TRIM** controls.

### NOTE

There is no switch to allow a choice between the **MIC** and the **LINE** inputs. Accordingly, connections should not be made to both inputs of a channel simultaneously.

### WARNING

Connection of microphone cables and microphones: to prevent hazard or damage, ensure that only microphone cables and microphones designed to the IEC 268-15A standard are connected.

Connexions des microphones et de leurs câbles: pour éviter tout endommagement, s’assurer de brancher uniquement des microphones et des câbles de microphones conçus selon la norme IEC 268-15A.

- ④ **TRIM** These controls allow the input levels from the **MIC** and **LINE** inputs to be adjusted over a range of  $56\text{dB}$ .

Turning these controls clockwise increases the level of the signal fed to the channel AD convertors.

- ⑤ **PHANTOM (+48V)** These switches allow  $+48\text{V}$  phantom power to be provided to the **MIC** channel inputs. These switches are arranged so that one switch controls the phantom power for four input channels (1 through 4, 5 through 8, 9 through 12, and 13 through 16).

## Other analog I/O

These inputs and outputs provide analog feeds to monitoring systems, etc. a balanced pair of stereo master outputs and an insert loop for these outputs.

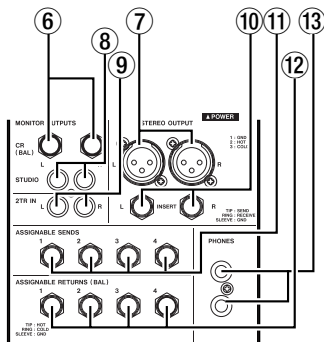

There are also four assignable sends and returns, as explained in “Setting up the I/O” on page 36.

- ⑥ **MONITOR OUTPUTS [CR (BAL)]** These 1/4” balanced analog outputs are used to provide monitoring signals to the control room as selected

using the monitor select switches ( $+4\text{dBu}$  nominal level).

- ⑦ **STEREO OUTPUT** This pair of balanced XLR connectors provides the analog stereo out signal at  $+4\text{dBu}$ .

- ⑧ **MONITOR OUTPUTS [STUDIO]** These unbalanced RCA connectors provide unbalanced signals to the studio at a nominal output level of  $-10\text{dBV}$ .

- ⑨ **2-TR IN** These two RCA unbalanced inputs are typically used for monitoring the replay from an analog mastering device at a nominal input level of  $-10\text{dBV}$ .

- ⑩ **STEREO OUTPUT [INSERT]** These 1/4” TRS connectors provide insert facilities for the **STEREO OUTPUTS**. The send (level  $-2\text{dBu}$ ) is post DA convertor and the return (level  $-2\text{dBu}$ ) is immediately before outputs.

## 4 – Parts of the DM-24—Top surface

⑪ **ASSIGNABLE SENDS** These balanced 1/4" jacks (–2dBu) are used either as insert sends for the input channels or as aux sends (see “Setting up the I/O” on page 36).

⑫ **ASSIGNABLE RETURNS (BAL)** These quasi-balanced returns (–2dBu) are either used as

aux returns or as insert returns for the input channels (see “Setting up the I/O” on page 36).

⑬ **PHONES** These two stereo 1/4" jacks provide headphone outputs.

### Module control section

This section is chiefly used for the control of the most commonly-used module parameters:

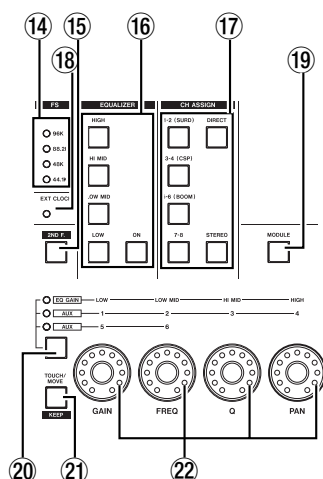

⑭ **FS indicators** These indicators show the current sampling frequency used by the system.

⑮ **2ND F. (MOVE) key** This key is mainly used in conjunction with the automation (purple) keys to access the secondary functions of these keys.

⑯ **EQUALIZER keys** As explained in “Rotary encoders (ring LEDs)” on page 15, four of these keys (**HIGH**, **HI MID**, **LOW MID**, **LOW**) are used to select the frequency band of the active module which will be affected by the rotary encoders. The **ON** key turns the EQ on and off for the selected module.

⑰ **CH ASSIGN keys** These keys are used to assign the selected module to the pairs of output bus-

ses (**BUSS 1-2**, **BUSS 3-4**, **BUSS 5-6** and **BUSS 7-8**) or to the stereo outputs (**STEREO**) or to direct output (**DIRECT**).

The legends in parentheses on the first three buss keys refer to surround assignments if a surround mode has been selected.

⑱ **EXT CLOCK indicator** If this indicator is lit, the DM-24 is referenced to external word sync. If unlit, the DM-24 is acting as the master word sync source for the system. If flashing, the clock source is not connected, or is not otherwise available for use by the DM-24.

⑲ **MODULE key** Pressing this key brings up the module editing screen, allowing the different parameters of a module to be viewed and edited.

⑳ **Encoder function select key and indicators** Successive presses of this key light, in order: no indicator, **EQ GAIN**, **AUX (1 through 4)** and **AUX (5 and 6)**, as explained in “Rotary encoders (ring LEDs)” on page 15. The indicators show the current function of the encoders.

㉑ **TOUCH/MOVE [KEEP] key** This key is used in conjunction with the automation software, as explained in the automation guide.

㉒ **Rotary encoders** These are used to set parameters as explained in “Rotary encoders (ring LEDs)” on page 15.

### Library section

These keys are used for the storage and recall of commonly-used parameters in snapshots, EQ settings, effects and so on.

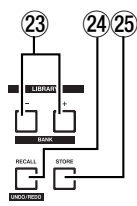

㉓ **LIBRARY + and – [BANK] keys** These are used to change the selected active library entry (usually shown at the top of the screen).

㉔ **RECALL [UNDO/REDO] key** The **RECALL** key is used to recall the settings of stored in the currently-select active library entry. It can also be used for comparison between the new and previous settings.

②⑤ **STORE key** This key stores the current settings to the currently-selected library entry.

## Parameter control section

This section is used to control the different parameters and to navigate through the different options available on the DM-24

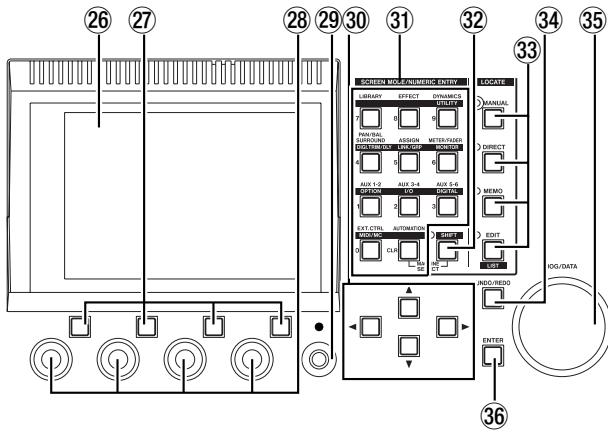

②⑥ **LCD display** This backlit display shows the parameters and values that can be adjusted, as well as pop-up status and error messages.

②⑦ **Soft keys** These four keys are used to select options and sub-screens shown at the bottom of the display (“Soft keys” on page 15).

②⑧ **PODs** These encoders are used to set values highlighted on the screen with the cursor (“PODs” on page 13).

②⑨ **Display contrast** Use this control to set the most convenient viewing angle for the display.

③① **Cursor keys** These keys are used to move the on-screen cursor to highlight the parameters to be edited with the PODs or the data dial.

③② **Number and predefined function keys** These keys are used to access the setting screens where global parameters may be set up and for changing between sub-screens.

The **SHIFT** key is also used to provide a secondary function for most of these keys, bringing up screens which probably will not be used so frequently.

In some location modes, these keys are used to enter numeric values directly:

Number	Unshifted function	Shifted function
CLR	<b>AUTOMATION</b> (automation) control	—
0	External device control ( <b>EXT. CTRL</b> )	MIDI and machine control parameters ( <b>MIDI/MC</b> )

Number	Unshifted function	Shifted function
1	Aux 1 and 2 sends ( <b>AUX 1-2</b> )	System options ( <b>OPTION</b> )
2	Aux 3 and 4 sends ( <b>AUX 3-4</b> )	Input and output assignment ( <b>I/O</b> )
3	Aux 5 and 6 sends ( <b>AUX 5-6</b> )	System setup options ( <b>SETUP</b> )
4	Pan and balance (surround settings if surround selected) ( <b>PAN/BAL SURROUND</b> )	Digital trim and channel delay ( <b>TRIM/DLY</b> )
5	Channel-to-buss assignment ( <b>ASSIGN</b> )	Stereo linking and fader/mute grouping ( <b>LINK/GRP</b> )
6	On-screen meters and fader	Monitoring settings and positioning ( <b>METER/FADER</b> )
7	Library settings and selection ( <b>LIBRARY</b> )	—
8	Effect settings and editing ( <b>EFFECT</b> )	—
9	Dynamics processor settings ( <b>GATE/DYN</b> )	Various system utilities ( <b>UTILITY</b> )

③② **SHIFT key and indicator** This is a “smart” key. Press and release it briefly to light the indicator. Press and release it briefly again to turn off the indicator.

Press and hold the key for more than about half a second to light the indicator for only as long as the key is held down (when the key is released, the indicator goes out).

When the indicator is lit, the predefined function keys will then perform their secondary shifted function (as marked on the lower label above the key).

③③ **LOCATE keys and indicators** These keys are used to set the way in which location of the currently-selected machine transport is controlled.

If any of these indicators is lit, the predefined function keys act as number keys (as explained in “Location memories” on page 85).

③④ **AUTOMATION UNDO key** This key is used with the automation system to undo changes made to automated mixes.

③⑤ **JOG/DATA dial** This dial is used for setting on-screen parameter values, etc. When the DM-24 is controlling the transport of a remote device, it may be used to perform a jog function.



## 4 – Parts of the DM-24—Top surface

③⑥ **ENTER key** Use this key to confirm entries and to answer “yes” to questions (the cursor keys are usually used to cancel or answer “no”).

### Monitoring section

This section is used to control what is heard from the control room and the studio monitoring systems. Since many of the choices here are “soft” choices (that is, determined by the software), the full explanation of these keys and indicators is provided in a separate section (“Monitoring” on page 73).

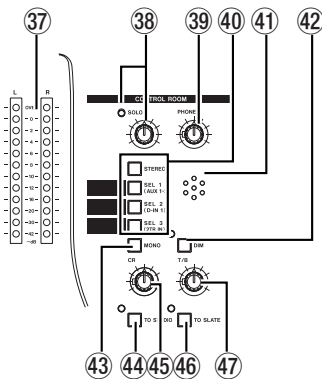

③⑦ **Meters** These meters show the level of the currently-monitored signal.

③⑧ **SOLO control and indicator** When the indicator is lit, soloing is enabled and a channel has been selected for soloing. The level of the soloed signal is controlled by this knob.

③⑨ **PHONES control** This control regulates the level of the signal sent to the phones outputs.

④① **Monitor selection keys** These keys are used to select the signal sent to the control room monitor outputs (and the phones outputs).

The **STEREO** key routes the stereo output signal to the monitor outputs. The **SEL 1**, **SEL 2** and **SEL 3** keys route the signals selected in the monitor screen to the monitor outputs.

④① **Talkback microphone** This integral microphone can be used for studio talkback or slate output.

④② **DIM key and indicator** This “smart” key works in the same way as the **STUDIO** key above.

When on, the control room outputs are attenuated (the amount is set using the monitor screen).

④③ **MONO** This outputs the selected signal in mono to the control room monitors and phones.

④④ **STUDIO key and indicator** This “smart” key latches on when pushed and released within a second, and is switched off by pushing it again in the same way. If pushed and held down for more than a second it is non-latching, that is, it turns off when released.

When on, the control room outputs are attenuated, and the talkback microphone signal is routed to the studio outputs.

④⑤ **CR volume control** This control adjusts the level of the signal selected with the selection keys and sent to the control room outputs and **PHONES** outputs.

④⑥ **TO SLATE key and indicator** This “smart” key works in the same way as the **STUDIO** key above.

When on, the control room outputs are attenuated and the talkback microphone signal is routed to the eight output busses, the stereo buss and the six aux busses.

④⑦ **T/B volume control** This control adjusts the level of the signal from the talkback microphone, fed to the selected outputs (slate or studio).



### Module faders and selection, etc.

The module faders are arranged in layers (see “Fader layers” on page 18). Accordingly, the 16 module faders are used to control all 32 inputs, the six aux sends and the output buss sends as shown on the pre-printed labels above and below each channel strip.

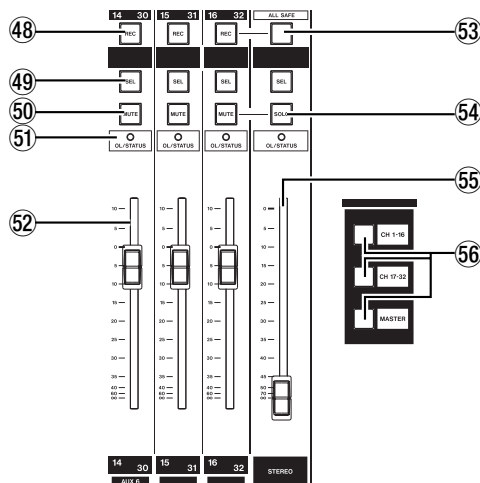

Note that a wipe-off surface is provided (below the **REC** keys) for you to write in soft pencil the functions of the channels (equipment connected to the DM-24, etc.).

- ④⑧ **REC key** These keys, with integral indicator, are used to set and show the recording status of tracks of devices controlled by the DM-24.
- ④⑨ **SEL keys** These keys, with integral indicators, are used to select the modules for editing operations, as well as for stereo linking and other editing

functions. The indicators light to show which module has been selected.

- ⑤⑩ **MUTE keys** These keys, with integral indicators, show the muting status of the modules. When used with the solo modes, they give instant indication of what module(s) are selected for soloing.
- ⑤⑪ **OL/STATUS indicators** These indicators may be selected using software to show either overload to the input channels or the current status of the channel when automation operations are being carried out. See “OL/STATUS LED TYPE” on page 20 for details of these settings.
- ⑤⑫ **Module faders** These 100mm motorized faders are labeled from  $\infty$  (full cut) to **+10** (dB). The **0** position may be set to be equivalent to the appropriate full-scale value using software.
- ⑤⑬ **ALL SAFE key** This key, with integral indicator, is used to “safe” any tracks of recording devices controlled by the DM-24.
- ⑤⑭ **SOLO key** This key, with integral indicator, is used to enable the soloing function as selected in “SOLO” on page 22.
- ⑤⑮ **STEREO fader** This fader does not change function as the layers are changed, but controls the level of the stereo outputs. It is labeled from  $\infty$  (full cut) to **0** (full scale).
- ⑤⑯ **LAYER STATUS keys** These keys (with integral indicators), as explained in “Fader layers” on page 18, change the function of the modules to provide access to the different fader layers.

### Transport and automation control

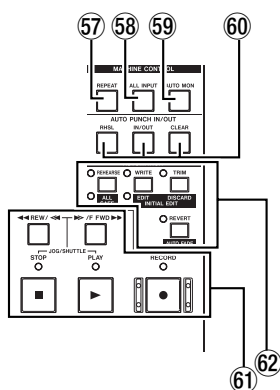

This controls in this section provide remote control facilities for recording devices, etc. attached to the DM-24.

- ⑤⑰ **REPEAT key** This key, with integral indicator, is used to control repeat playback.
- ⑤⑱ **ALL INPUT key** Provides input monitoring for all tracks on the selected unit(s).
- ⑤⑲ **AUTO MON key** Provides automated switching between input and off-tape monitoring.
- ⑥⑰ **AUTO PUNCH IN/OUT keys** Typically used with the DTRS family of recorders.
- ⑥⑱ **Transport keys and indicators** The exact function of these keys (**REW**, **F FWD**, **STOP**, **PLAY** and **RECORD**) and indicators depends on the device currently selected for external control.

## 4 – Parts of the DM-24—Rear panel

**⑥ Automation control keys and indicators** These keys (**REHEARSE**, **WRITE**, **TRIM** and **REVERT**) are used to control the automation functions. These keys have other functions, as selected by the **2ND F** key (⑮).

### NOTE

Although some of these keys have similar names to other keys on the DM-24, note that their functions are restricted to automation operations.

## Rear panel

The rear panel of the DM-24 houses the digital audio and control connections.

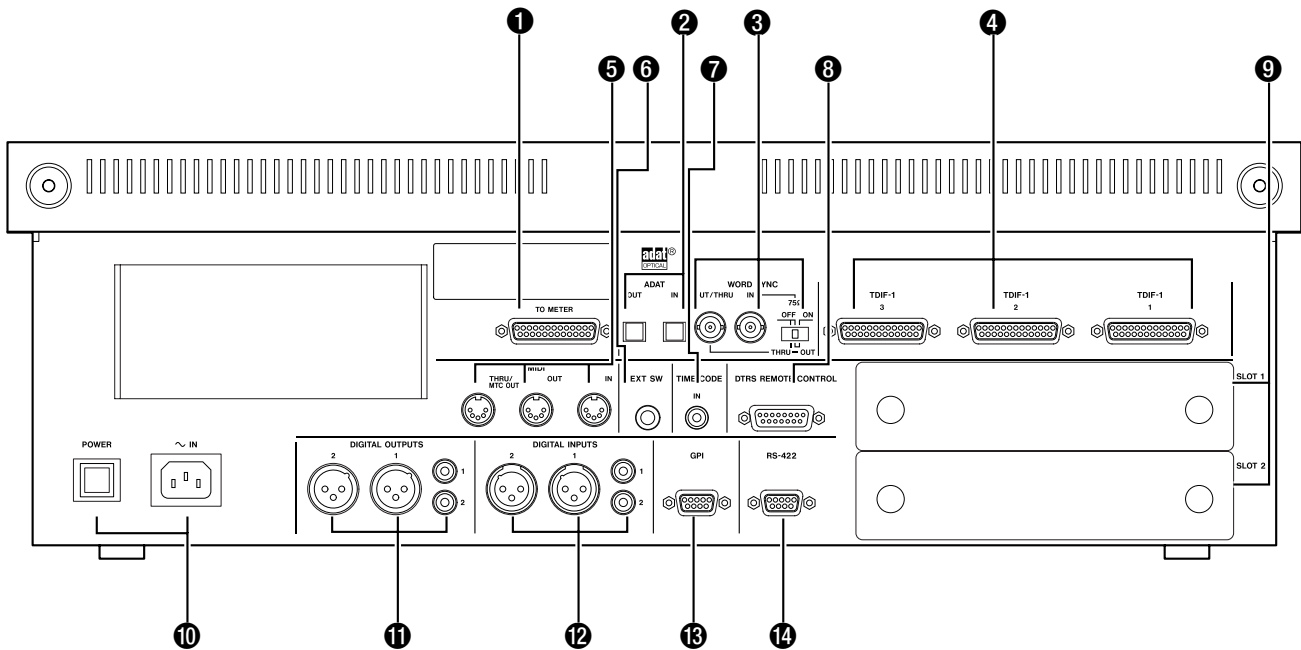

### NOTE

Only use TASCAM-supplied and TASCAM-approved cables when making digital audio and control connections to the DM-24. Though the cables and connectors may resemble computer cables, they serve different purposes, and meet a different set of specifications. The use of cables other than TASCAM cables will at best cause the equipment to work erratically, and at worst cause damage to the equipment.

If the use of cables other than TASCAM cables causes or results in damage, the warranty is voided.

**① TO METER** This 25-pin ‘D’-sub connector is used to connect the DM-24 and the optional MU-24/DM meter unit.

**② ADAT [IN, OUT]** Use these “lightpipe” connectors to connect ADAT-compatible units to the DM-24 with a Toslink-type optical cable. Each of these connectors carries eight digital audio input or outputs channels.

The input may be used as a clock source, and routed to any of the three groups of eight input channels (1 through 8, 9 through 16, 17 through 24).

**③ WORD SYNC [OUT/THRU, IN] and switch** These BNC connectors are used for word sync. The switch controls the behavior of the connectors (75Ω input impedance and switching between OUT and THRU functions) as described here:

Position	75Ω IN termination?	OUT/THRU
Left	No	Thru
Center	No	Out
Right	Yes	Out

A **THRU** setting means that the connector echoes the word sync signal received at the **IN**. An **OUT** setting means that the DM-24 originates a word sync signal (and is therefore to be the word sync master for the system).

**4 TDIF [1, 2 3]** These 25-pin ‘D’-sub connectors are used for the connection of suitably-equipped digital audio devices.

At the base rates of 44.1k and 48k, each connector carries eight channels of input and eight of output. These numbers are halved when dual-frequency sampling frequencies (88.2k and 96k) are used.

These may be routed to any of the three groups of eight channels capable of accepting return signals (1 through 8, 9 through 16, 17 through 24).

**TDIF 1** only may be selected as the clock source for the system.

**5 MIDI IN, OUT and THRU** These three 5-pin DIN connectors correspond to the MIDI standard (**MIDI IN** receives MIDI data, **MIDI OUT** outputs MIDI data originated by the DM-24, and **MIDI THRU** echoes data received at **MIDI IN**).

The MIDI is used for MIDI Timecode, Program Change and Control Change messages, as well as for MIDI System Exclusive bulk data dumps, etc. The details of these are all given in the section on MIDI (“MIDI” on page 95).

**6 EXT SW** This 1/4” jack is used to connect a footswitch (for example, the TASCAM RC-30P), which is selectable through software to provide a variety of functions.

**7 TIME CODE** This unbalanced RCA connector accepts SMPTE/EBU analog timecode.

**8 DTRS REMOTE CONTROL** This 15-pin ‘D’-sub connector connects to the first unit in a chain of DTRS recorders, allowing the DM-24 to remotely control the recorders.

**9 SLOT [1 and 2]** These expansion slots allow the fitting of optional cards, such as a cascade card, AES/EBU interfaces, additional “lightpipe” interfaces, or additional AD-DA conversion interfaces.

Consult your TASCAM dealer for availability of such cards, and the documentation supplied with the cards for details of how to fit and use them.

**10 POWER SWITCH and IN** Use this push-on/push-off switch to switch the power to the DM-24. Use only the provided power cord to connect the DM-24 to the AC supply, ensuring that the voltage of the supply matches the voltage requirements as given on the rear panel of the DM-24. If you are in any doubt, consult a qualified electrician.

### NOTE

*The equipment draws nominal non-operating power from the AC outlet with its **POWER** switch in the OFF position.*

**11 DIGITAL OUTPUT 1 and 2** Each of these outputs has two connectors: an XLR-type and an RCA connector. The format of the output is determined by software.

The function of these connectors (master stereo output, stereo aux send, etc.) is also determined by software settings.

**12 DIGITAL INPUT 1 and 2** Each of these inputs has two connectors: an XLR-type and an RCA connector. Only one connector at a time can be used for the input (selected by software).

The routing of these connectors is also determined by software settings.

**13 GPI** This 9-pin ‘D’-sub connector is a General Purpose Interface, used for remote control of devices attached to the DM-24.

**14 RS-422** This 9-pin ‘D’-sub connector is a remote control interface, to the RS-422 standard, allowing remote control of devices attached to the DM-24.

## 5 – Setting up the I/O

Because the DM-24 is a “soft” digital mixing console, there are few of the hard-wired assignments that you find on an analog console.

In addition, the DM-24 includes an internal patchbay, which allows routing and splitting of signals within the console, providing a high degree of flexibility, and easy re-configuration when the requirements within a project change.

These routing and configuration settings can be stored in snapshot settings, allowing easy switching between the commonly-used routing patterns (for example, tracking, overdubbing and mixdown).

---

### Signal sources

---

The DM-24 defines channel signal sources as *inputs* and *returns*, as explained here.

In the I/O assignment screens, each channel from 1 through 24 has two different sources—*input* and *return*—available (channels 25 to 32 have only one source—*input*—available):

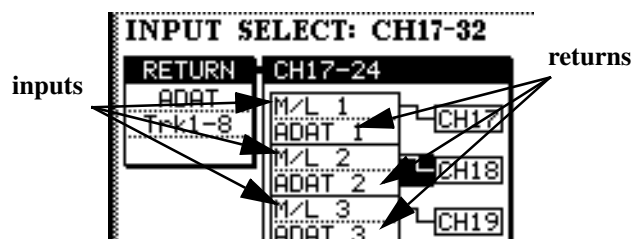

In this illustration, the mic/line inputs are selected as the *inputs* (upper box) for channels 17 through 24.

The ADAT connector audio is selected as the *return* source (lower box) for these channels.

**Sixteen mic/line analog inputs** are available on the DM-24. These are referred to on-screen as M/L.

They may be assigned to the console channels numbered 1 through 32. These are *inputs*.

**Three TDIF connectors** (1 through 3) carry eight channels of I/O digital audio each (in base frequency mode—in dual-frequency mode, this situation is different).

These TDIF inputs may also be assigned to console channels numbered 1 through 24.

These are *returns*.

The library facilities also allow the retention of I/O patches, etc. between snapshots, so that the I/O settings are not always overwritten by the recalled snapshot. See “Protecting snapshot settings” on page 102 for full details.

#### NOTE

*This section deals only with the assignments in normal sampling frequency modes (either 44.1k or 48k). If the DM-24 is to be used in high sampling-frequency mode, the screens and the options are a little different. See “High sampling frequency” on page 112 for details.*

**ADAT connector** The single “lightpipe” ADAT input connector carries eight channels of digital audio input.

The eight audio channels received through this connector may be assigned to any of the console channels numbered 1 through 24.

These are *returns*.

**DIGITAL IN 1 & 2** Each of these logical inputs has two physical connectors: an XLR, typically used for AES/EBU connections, and an RCA jack, typically used for SPDIF connections. One of these can be selected for each logical input, and routed to any of the console channels numbered 1 through 32. These are *inputs*.

**Card slots** Optional cards may be installed in the two card slots for expansion of the digital and analog I/O. These are treated as *returns*, and may be routed to the channels 1 through 24.

**Assignable returns** These four balanced analog inputs may be assigned as channel inputs (for example, when they are used with external effect processors).

These are *inputs* and are assignable to channels 1 through 32.

**Internal effectors** The DM-24 has two internal digital effectors, with stereo returns.

These returns are *inputs* and are assignable to channels 1 through 32.

## Output signals

The following are the signals output from the DM-24 (excluding the monitoring signals):

**Eight output busses** These busses are typically routed to the built-in multi-track outputs (TDIF and ADAT) or to the optional slot cards.

**Six aux busses** These six aux busses may be routed to the assignable sends, as well as to the internal effect units.

## Physical outputs

This excludes the monitoring outputs (control room, studio, etc.).

**TDIF-1 connectors** These connectors are used as outputs as well as inputs, carrying eight channels each in normal-frequency mode. In dual-frequency mode situation this is different.

**ADAT OUT connector** This lightpipe connector can be used as outputs from busses or as direct output. It carries eight channels in normal-frequency mode.

**Stereo master outputs** These stereo outputs are typically used as the sum of the mixed output busses (except in surround mode).

**Direct outputs** The signals from the channels can be output directly, not passing through busses, etc. to the connectors (TDIF, ADAT, slot) below.

**Slot cards** These may act as outputs, depending on the cards installed.

**Assignable sends** These sends may be used as either analog insert sends or as aux sends.

**Digital outputs (x 2)** Can be assigned to output the stereo buss, adjacent pairs of busses, adjacent pairs aux busses or the control room source.

**STEREO OUTPUTS (L, R)** Used as the analog outputs for the stereo master buss.

## Patching between input and return

The DM-24 allows you to switch between the assigned inputs and returns for channels 1 through 24 without having to connect or disconnect cables. The sources for channels 25 through 32 are not selectable in this way.

These switches are accessed from the I/O screens.



- 1 With the **SHIFT** indicator lit, press the **I/O** key.
- 2 Press either the first or second soft key to bring up the channel assignment screens.

The on-screen channels have two columns, the sources, and the destinations, with a “patch cable” connecting them.

The source column has two alternative sources for each channel: the *input* (top) and the *return* (bottom) sources.

Move the cursor to the “patch cable” and turn the dial.

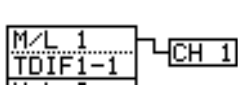
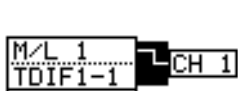
### 3 Press ENTER to confirm the change.

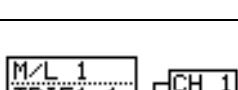
	Mic/line input 1 is routed to input channel 1
	The cursor is moved to highlight the “patch cable”
	The dial has been turned to “repatch” TDIF1 channel 1 to channel 1
	The <b>ENTER</b> key has been pressed to confirm the repatching process.

#### NOTE

This switching can also be done in the fourth MODULE screen (“Channel source (CH SOURCE)” on page 58).

## 5 – Setting up the I/O—Assigning inputs to channels

### Assigning inputs to channels

The I/O screens control the input/output assignments, as explained here:

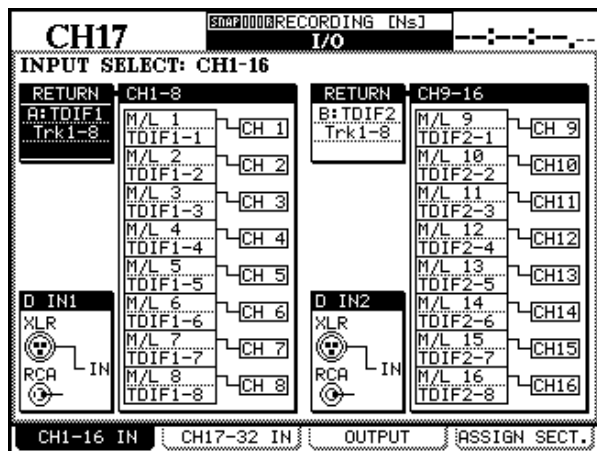

- 1 With the **SHIFT** indicator lit, press the **I/O** key.

There are four tabs at the bottom of the screen. The two leftmost tabs, accessed through the first two soft keys, control the inputs to the first sixteen (CH1-16 IN) and second sixteen (CH17-32 IN) channels, respectively.

- 2 Press either of the two soft keys described above. These screens control the selection of the return block, the input source, and the

choice between input and return for each channel, as well as the input source for the **DIGITAL IN** signals.

Each of the channels from 1 through 24 can be used either as an input or a return, as described above.

In the screen above, the mic/line inputs are assigned to the first sixteen channels, which would be an appropriate setting for the recording phase of a project. In the screen below, however, tape returns from TDIF groups 1 and 2 are assigned to these channels (for mixdown).

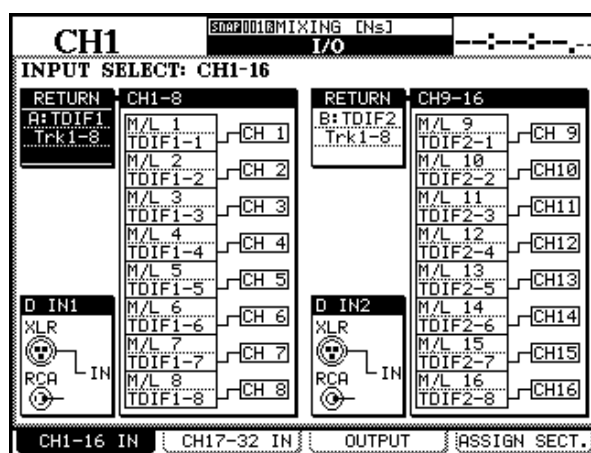

Channels 25 through 32 can be used for input only.

### Input sources

Any mic/line input can be assigned to any channel (1 through 32). The same mic/line input can be assigned to more than one channel, if required.

- 1 In either of the two channel I/O screens, move the cursor to the source column of the group of channels.
- 2 Use the **▲** and **▼** keys to move up and down the column.

#### NOTE

Note that the returns (as explained below) are pre-mapped and cannot be changed here. The cursor never highlights them.

- 3 Use the dial to select from the available options as listed here (x represents a displayed number in this table):

Screen display	Meaning
M/L x	Mic/line analog input x
D-INx-L (or R)	Digital input x (1 or 2) – either the left or the right channel
ASN RTNx	One of the four assignable returns
EFF x-L (or R)	Internal effector 1 or 2, left or right channel

#### NOTE

Since input sources can be shared (routed to more than one input at once), simultaneous recordings can be made of the same take. For example, you can try recording the same vocal take with different compression or EQ settings.

## Return modules

Return sources are available for channels 1 through 24 (channels 25 through 32 are input only).

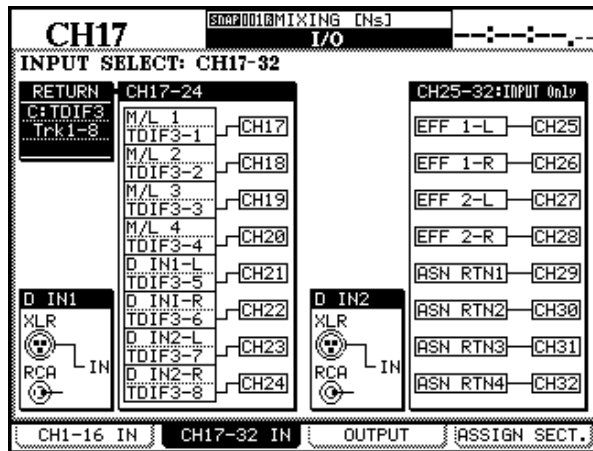

The return options for each group of eight channels are selected by moving the cursor to the RETURN field at the left of the list of channels, and using the dial to select from the available options.

Press **ENTER** to confirm the setting.

### NOTE

*If a slot card has not been fitted, an error message appears. Press **ENTER** to dismiss the message.*

Each group of eight channels is assigned to use the same return source block (though it is possible to mix inputs and returns within the same block).

It is important to note the following:

- The returns from TDIF1-1 cannot be assigned and used at the same time as the returns from a card fitted in slot 1.
- The returns from TDIF1-2 cannot be assigned and used at the same time as the returns from a card fitted in slot 2.
- The returns from TDIF1-3 cannot be assigned and used at the same time as the returns from the internal ADAT connector.

## Digital inputs

Each digital input has two connectors; an XLR-type connector and an RCA pin jack. One of these is selected for input as described here.

These connectors can both be used for either AES/EBU or SPDIF data, and the data format is automatically detected by the DM-24—no settings are necessary to choose the data format.

The first 24 channels may have the following sources assigned to them as returns:

Channel	Return signal
1,9,17	TDIF1-3 Trk1 / Slot1-2 Trk1 / Slot1-2 Trk9 / Slot1-2 Trk17 / ADAT Trk1
2,10,18	TDIF1-3 Trk2 / Slot1-2 Trk2 / Slot1-2 Trk10 / Slot1-2 Trk18 / ADAT Trk2
3,11,19	TDIF1-3 Trk3 / Slot1-2 Trk3 / Slot1-2 Trk11 / Slot1-2 Trk19 / ADAT Trk3
4,12,20	TDIF1-3 Trk4 / Slot1-2 Trk4 / Slot1-2 Trk12 / Slot1-2 Trk20 / ADAT Trk4
5,13,21	TDIF1-3 Trk5 / Slot1-2 Trk5 / Slot1-2 Trk13 / Slot1-2 Trk21 / ADAT Trk5
6,14,22	TDIF1-3 Trk6 / Slot1-2 Trk6 / Slot1-2 Trk14 / Slot1-2 Trk22 / ADAT Trk6
7,15,23	TDIF1-3 Trk7 / Slot1-2 Trk7 / Slot1-2 Trk15 / Slot1-2 Trk23 / ADAT Trk7
8,16,24	TDIF1-3 Trk8 / Slot1-2 Trk8 / Slot1-2 Trk16 / Slot1-2 Trk24 / ADAT Trk8

As can be seen, it is possible for the same return to be assigned to more than one channel at the same time (of course, it is not possible for one channel to accept the signal from more than one return at the same time).

Although the return module for each block can be selected, the channels of the module cannot be changed. For example, if an MTR return is assigned to channels 1–8, track 2 of an MTR cannot be assigned to channel 1. Track 3 can only be assigned to TDIF channel 3 (in the TDIF1, TDIF2, TDIF3 return source blocks), or ADAT channel 3, etc.

Note, though that when slot cards are fitted, the number of the channel in the slot card may be offset by 8 or 16, so that channel 9 (or 17) of slot card 2 may be assigned to channel 1, etc.

See “The FORMAT screen” on page 26 for details of how to set the parameters for sampling frequency conversion, etc. at these inputs.

However, although there are two physical connectors for these inputs, the audio data for an input can only be accepted from one of these connectors at any one time.

## 5 – Setting up the I/O—Channel-to-buss assignments (global)

The inputs are chosen in a similar way to the input/return selection for channels 1 through 24.

The cursor is moved to the “patch cord” linking the inputs to the digital input (either D IN1 or D IN2), and

the dial and **ENTER** key are used to change the “patch” setting.

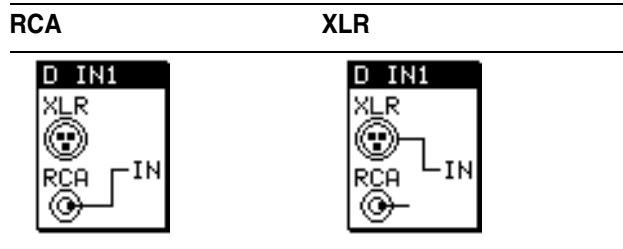

### Channel-to-buss assignments (global)

These may be made either on a central “global” basis, or individually, channel by channel.

#### NOTE

Surround modes are treated in a similar, but different, manner. See “Surround operations” on page 107 for full details of how to make assignments in surround mode.

To use the global screen:

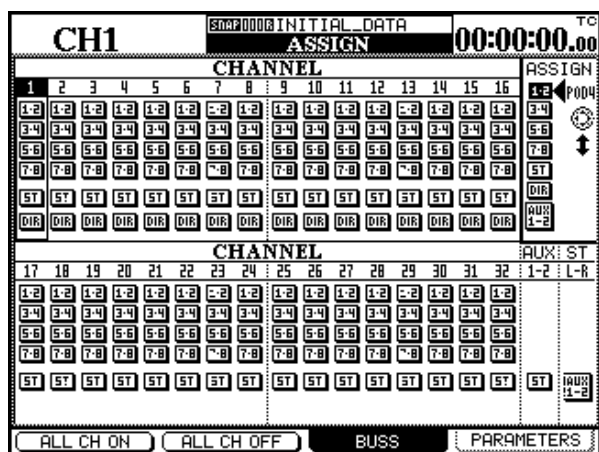

- 1 With the **SHIFT** indicator off, press the **ASSIGN** key.
- 2 Continue to press the **ASSIGN** key, or press soft key 3 to display the **BUSS** screen.
- 3 Use the **◀** and **▶** keys or dial to move the cursor along the row. The **▲** and **▼** keys move between the blocks, and the **SEL** indicator of the currently-highlighted channel lights (if the fader layer containing the channel is selected).

Alternatively, use the **SEL** keys of the channels to move the cursor and highlight the channels on the screen. Channel 1 is highlighted here.

- 4 Use **POD 4** to move the cursor at the right of the screen to select the buss groups (1-2, 3-4, 5-6 and 7-8), the stereo output (ST), direct out (DIR) or AUX 1-2 (see below).
- 5 Press **ENTER** to assign/de-assign the highlighted channel to and from the selected group. The appropriate **CH ASSIGN** key indicators light and go out as the selections are made in this way.

Alternatively, if the **SEL** key of the selected channel is lit (that is, the fader layer of the selected channel is active), use the dedicated **ASSIGN** keys to change the assignments.

#### NOTE

Direct output is only possible from channels 1 through 16.

**Master settings** The on-screen buttons **ALL CH ON** (soft key 1) and **ALL CH OFF** (soft key 2) are used to assign or de-assign all channels from the assignment highlighted using **POD 4**.

**AUX 1-2** The **AUX 1-2** setting at the bottom of the **POD 4** list does not have a corresponding hardware key or indicator. It is used to switch a link between the stereo output and aux 1-2, or aux 1-2 may be assigned to the stereo outputs. Obviously, only one of these assignments may be made at one time.

The first of these assignments (stereo to aux 1-2) is only possible when the **AUX 1-2** **POD 4** button is highlighted, and when the cursor is on the **ST** module (bottom right of screen).

The second such assignment (aux 1-2 to stereo) is possible only when the **AUX 1-2** **POD 4** button is **not** highlighted, and the cursor highlights the **AUX** module (to the left of the **ST** module—lower right).

In either case, press the **ENTER** key. If the other assignment has been made, a popup message appears



# 5 – Setting up the I/O—Channel-to-buss assignments (global)

(STEREO to AUX1-2 is assigned. or AUX1-2 to STEREO is assigned.). Press **ENTER** again to dismiss the message, then unlink the existing assignment, and retry the link of the new assignment.

When the link is successfully made, the appropriate on-screen indicator is reversed.

## Channel-to-buss assignments by channel

This method allows the setting of channel-to-buss assignments per channel.

- 1 Select a channel using the **FADER LAYER** keys and the **SEL** key of the channel (either **SEL** key if the channel is part of a stereo link pair).
- 2 Use the **CH ASSIGN** keys to the left of the display to assign and de-assign channels to and from busses.

**If the assignment is not possible (for instance, no direct out is possible for channels 17 through 32), the appropriate key is disabled.**

If either the **MODULE** or the **ASSIGN** screen is displayed, changes made to the assignments using these keys will be reflected in the display.

## Other module parameters

Phase, gate on/off, compressor on/off, pre- or post-EQ compressor location, and EQ on/off can all be set in the **PARAMETERS** sub-screen of the **ASSIGN** display. Press soft key 4, or the **ASSIGN** key until this sub-screen is displayed.

Use **POD 4** to select the type of parameter to be changed, and the cursor keys to move between the modules, as before.

The parameters selected by **POD 4** are:

$\Phi$	Phase on and off (inverse signifies phase reversal)
GAT	Gate switch on/off (inverse signifies on)
CMP	Compressor switch on/off (inverse signifies on)
INS	Compressor insert point (changes between PRE (pre-EQ) and PST (post-EQ))
EQ	Turns EQ on and off (inverse signifies on)

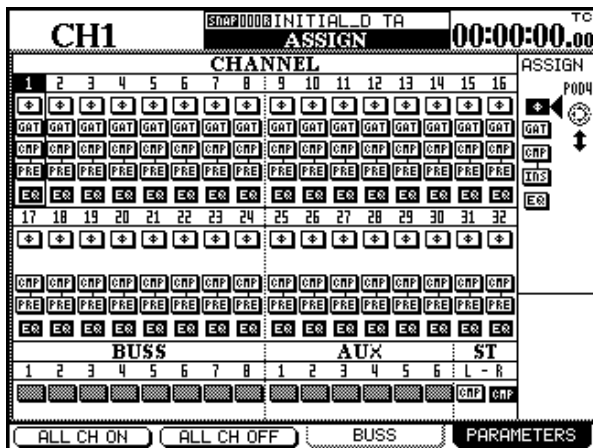

Note that channels 17 through 32 cannot have a gate assigned to them.

If a compressor has been assigned to any of the master modules (aux or buss or stereo as described in “Master compressors” on page 43), this will appear at the bottom of the screen, otherwise, a gray box will be shown.

## 5 – Setting up the I/O—Output assignments

### Output assignments

The buss settings and the aux sends 1 through 4 may be routed to the three internal TDIF slots, as well as to the ADAT output and any slot cards fitted.

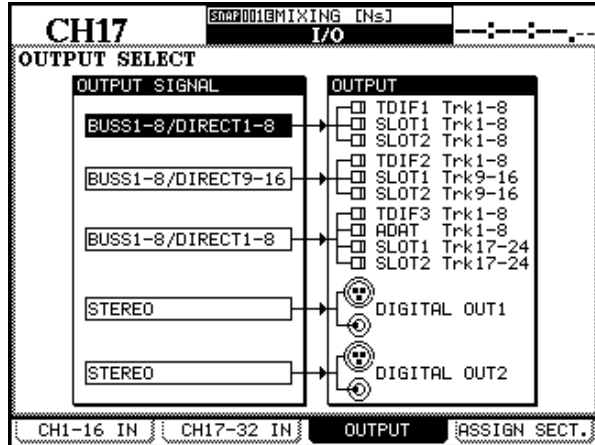

The output grouping destinations are grouped in *output blocks* of eight signals. *Block sources* (busses, direct outputs or aux sends) are mapped to these blocks. The blocks are grouped together, and the block sources are sent in parallel to all blocks in the group

The eight output busses are assigned on a one-to-one basis to the outputs within a block (that is, buss 1 will feed channel 1 of the output block, etc.)

#### NOTE

*The more recent models of TASCAM DTRS recorder have an internal patchbay which allows you to reassign inputs to tracks.*

If a direct out has been selected in the assignments (“Channel-to-buss assignments (global)” on page 40), this will take priority over the buss outputs (the appropriate buss output will not be selected for the block/channel combination used by the direct outs).

The composition of the output blocks, and the choices for the block sources are:

Block	Output block groups	Block Source options
1	TDIF 1 (1–8) Slot 1 (1–8) Slot 2 (1–8)	Buss 1–8 / Direct out 1–8 Aux 1–4 Parallel (paralleled 1->1&5, 2->2&6, etc.)
2	TDIF 2 (9–16) Slot 1 (9–16) Slot 2 (9–16)	Buss 1–8 / Direct out 9–16 Aux 1–4 Parallel (paralleled 1->1&5, 2->2&6, etc.)
3	TDIF 3 (17–24) ADAT (17–24) Slot 1 (17–24) Slot 2 (17–24)	Buss 1–8 / Direct out 1–8 Buss 1–8 / Direct out 9–16 Aux 1–4 Parallel (paralleled 1->1&5, 2->2&6, etc.)

In the I/O OUTPUT sub-screen, use the dial and **ENTER** key to select the source for each output block.

### Digital outputs

The two **DIGITAL OUTPUTS** may output: the stereo outputs (STEREO), a pair of busses (BUSS1–2, BUSS3–4, BUSS5–6, or BUSS7–8), a pair of aux sends (AUX1-2, AUX3-4, AUX5-6) or the control room signal (C.ROOM).

The XLR and RCA connectors for each output are fed in parallel with the selected signal, and the format

is determined in the DIGITAL FORMAT screen (“Digital output” on page 26).

Move the cursor to the appropriate field (DIGITAL OUT1 or DIGITAL OUT2) on the left of the screen, Use the dial and **ENTER** key to select the desired output signal.

## Assignable sends and returns

The four sets of analog I/O connectors may be used as either analog insert points for selected channels or as the send part of effect loops (I/O display, ASSIGN SECT. sub-screen, accessed with soft key 4).

CH17		SNAP001 MIXING [NS]		I/O	
ASSIGNABLE SEND/RETURN				MASTER COMP INSERT MATRIX	
S/R	MODE	CH	POINT	ON/OFF	
1	<input type="radio"/> INSERT <input checked="" type="radio"/> SEND/RETURN	AUX3	→	SEND1	
2	<input type="radio"/> INSERT <input checked="" type="radio"/> SEND/RETURN	AUX4	→	SEND2	
3	<input type="radio"/> INSERT <input checked="" type="radio"/> SEND/RETURN	AUX5	→	SEND3	
4	<input type="radio"/> INSERT <input checked="" type="radio"/> SEND/RETURN	AUX6	→	SEND4	
					POINT:PRE FADER

Move the cursor to the INSERT or SEND RETURN radio button and press **ENTER** to make the setting for the appropriate assignable connectors.

If the insert mode is selected, move the cursor to the channel (CH) column, and use the dial and **ENTER** key to select and confirm the channel (any channel from 1 through 32 can be entered here). There is also an “off” setting (all fields are filled with ---).

The location of the insert can be selected (pre/post fader) in the POINT field and the insert loop turned on or off (ON/OFF button) in the ON/OFF column.

If the send loop is selected (the SEND/RETURN radio button is selected), the send signal source (AUX 1 to AUX 6) can be selected. To select the send signal source, move the cursor to the SEND SIGNAL field, then use the dial and **ENTER** key to select and confirm the source.

### NOTE

*The assignable returns can be assigned to the inputs in the first and second I/O screens (“Assigning inputs to channels” on page 38).*

## Master compressors

To assign up to six compressors (in three stereo pairs) to the STEREO L-R, the aux sends or the output busses, move the cursor to one of the pairs of MASTER fields (1-2, 3-4 or 5-6) at the right of the screen.

MASTER COMP INSERT MATRIX		
COMP	MASTER	ON/OFF
1	STEREO L	<input type="radio"/>
2	STEREO R	<input checked="" type="radio"/>
3	AUX1	<input type="radio"/>
4	AUX2	<input checked="" type="radio"/>
5	---	<input type="radio"/>
6	---	<input type="radio"/>
POINT:PRE FADER		

Press **ENTER**, and use the dial to select an adjacent pair of aux sends or output busses. Confirm the selection with the **ENTER** key.

Set the compressor for each of the master pairs on or off using the **ENTER** key when the cursor is on the appropriate on-screen button (or using the ASSIGN PARAMETERS screen—“Other module parameters” on page 41).

## 6 – Hookup

This section explains how to connect the DM-24 to other equipment, dividing the connections into analog, digital and sync/control type connections.

These are not sample setups, but pointers to the capabilities of the DM-24 when used with other equipment in your setup.

### NOTE

Always turn off the power to the DM-24 and other equipment when making and breaking connections.

Reapply power in the direction of source to destination (for example, turn on any external effect units and electronic instruments or other audio source first, followed by the DM-24 and any recording devices, and finish with the monitoring system).

Refer to “Parts of the DM-24” on page 28 for details of the specific terminals and connectors named in this section, and to “Setting up the I/O” on page 36 for details of how the internal assignments and patching are performed inside the DM-24.

## Analog connections

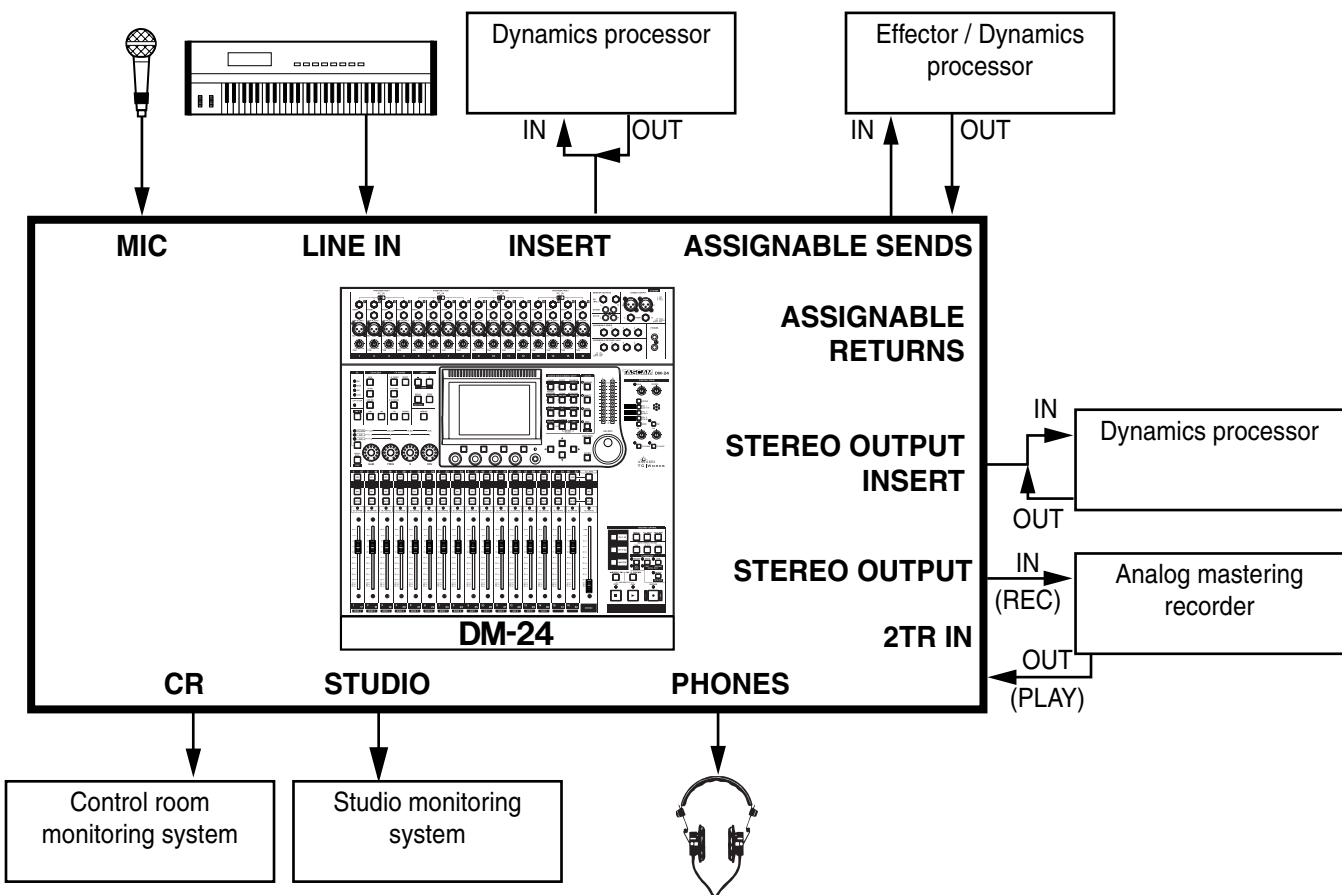

## MIC/LINE connections

The main analog inputs are the mic/line source connections made to the **MIC/LINE** connectors at the top of the unit.

Both sets of connectors are balanced (though when unbalanced plugs are inserted into the **LINE** 1/4" jacks, these are used as unbalanced inputs).

### NOTE

Only one connector of each channel (XLR or 1/4") should be in use at any one time. Do not make connections to both the 1/4" jack and the XLR connector of a

single channel). There is no way to switch between them.

The **MIC** XLR connectors can be supplied with phantom power (+48 V). This is switched in blocks of four, with one switch controlling the phantom power supply to inputs 1–4, 5–8, 9–12, and 13–16.

### NOTE

Always take care when switching the phantom power, to ensure that devices which may be damaged if phantom power is supplied are not connected to XLR connectors where phantom power is supplied.

The way in which these inputs are used by the channel modules is described in “Setting up the I/O” on page 36.

Use the **TRIM** controls to adjust the gain of the **MIC** and **LINE** inputs.

As explained in “OL/STATUS LED TYPE” on page 20, the LEDs by the faders can be used as signal level or overload indicators. Set the level at which they light to match your working conditions.

---

### External dynamics processors and effectors

Use the **MIC/LINE** channel **INSERT** connectors for the connection of external dynamics processors for channels 1 through 16.

There is no software control to turn these on or off.

Note that the position of these inserts is fixed as post-trim, and immediately before the AD convertor.

The assignable sends and returns can be set up as insert loops or as send/return effect loops “Assignable sends and returns” on page 43).

When used as inserts, these are available for channels 1 through 32.

When used as send/return loops, aux sends 1 through 6 may be assigned to the sends, and the returns are made through any channel.

---

### Analog monitoring and mastering

The main stereo buss signal is output from the **STEREO OUT** terminals, which should therefore be connected to the analog mastering machine.

Return the analog mastering machine into the **2TR IN** terminals. These are assigned by default to the **SEL 3**

monitoring selection key for easy monitoring of the two-track master in the control room.

Connect the two independent monitoring output sources (**CR** and **STUDIO**) to the appropriate monitoring systems.

## Digital connections

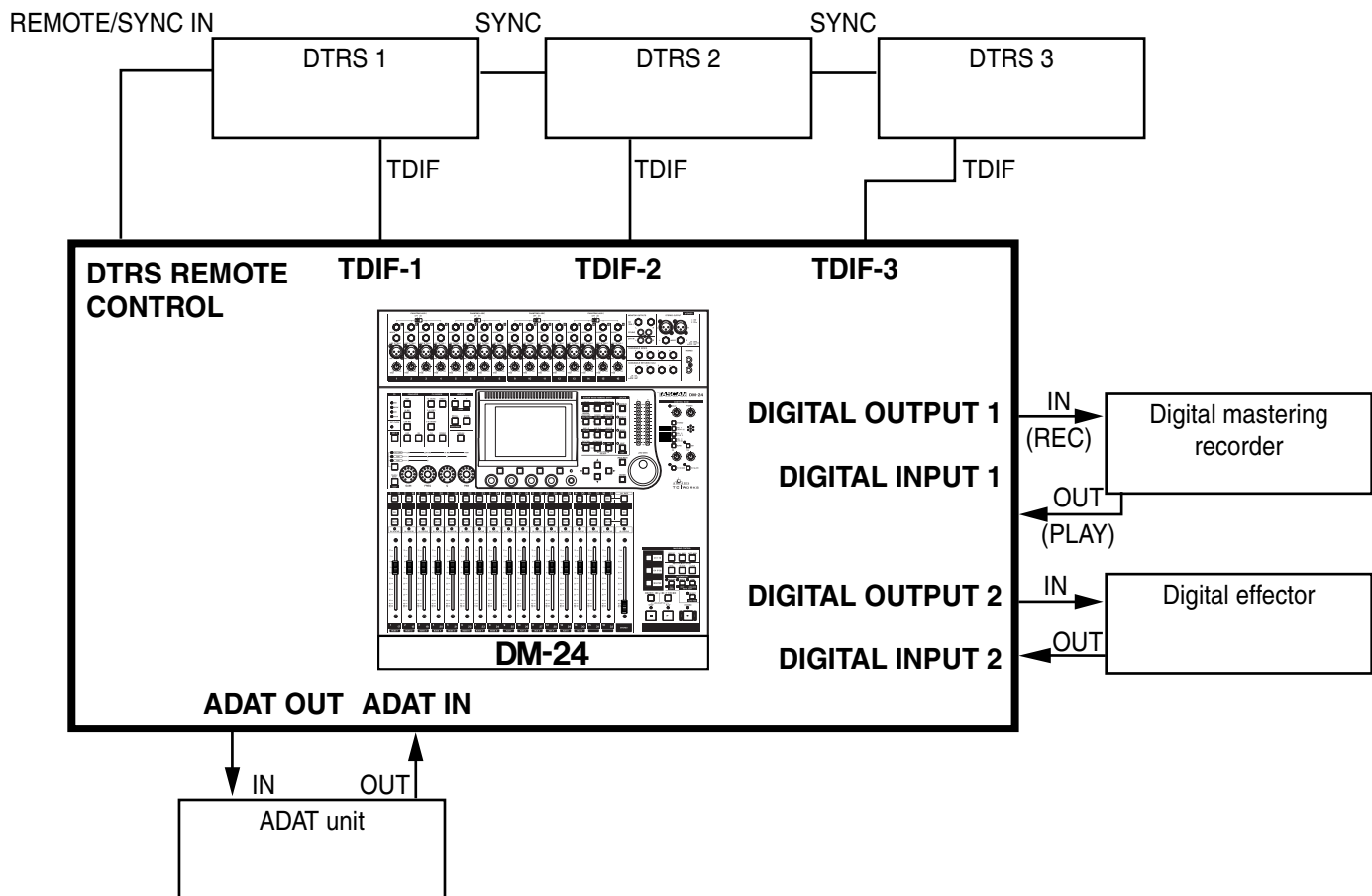

The digital audio connections mentioned here refer to the standard (non-expanded) model and are all made on the rear panel of the unit.

If expansion slot cards have been fitted, consult the appropriate documentation for these cards for full details of operations, etc.

### DTRS recorder connections

#### WARNING

*Only use TASCAM-supplied and TASCAM-approved cables when making digital audio and control connections to the DM-24. Though the cables and connectors may resemble computer cables, they serve different purposes, and meet a different set of specifications. The use of cables other than TASCAM cables will at best cause the equipment to work erratically, and at worst cause damage to the equipment. If the use of cables other than TASCAM cables causes or results in damage, the warranty is voided.*

Connect the appropriate TDIF interface of the DM-24 to the TDIF interface of the DTRS unit using a TASCAM cable. The interface carries both input and output signals.

Use an appropriate TASCAM remote cable to connect the **DTRS REMOTE CONTROL** connector of the DM-24 to the **REMOTE/SYNC IN** of the first DTRS unit in a chain. Connect the **SYNC OUT** of this unit to the **REMOTE/SYNC IN** of the next unit in the chain, and so on. Remember to terminate the last unit in the chain.

Control the remote DTRS units as described in “External control” on page 87.

The TDIF signal can carry timing signals, but for reliability, it is suggested that a separate word connection is made wherever possible, whether the DM-24 will be acting as a word clock master or as a slave. This connection need only be made to the first DTRS unit in the chain (with the lowest ID). Other units in the chain receive their clock through the **REMOTE/SYNC** connections.

## 6 – Hookup—Synchronization and control connections

### ADAT connections

Use two TOSLINK-type fiber cables to connect the ADAT device (**ADAT IN** to **OUT** on the remote device) and **ADAT OUT** to **IN** on the remote device).

If the ADAT is to be controlled from the DM-24, a third-party device to convert MMC to ADAT sync

commands will be necessary. Examples of such devices are the JL Cooper dataSYNC<sup>2</sup>, or the MOTU MTP AV. These convert the ABS code from the ADAT to MTC, allowing synchronization for automation purposes.

### Digital inputs and outputs

The two sets of digital inputs and two sets of digital outputs each comprise an XLR-type connector and an RCA pin jack. Typically, the XLR-type connector will be used for AES/EBU digital audio, while the RCA is used for SPDIF.

These inputs can be assigned to any of the channel modules (1 through 32). They can therefore be used as returns from digital effects units, etc. as well as source inputs from CD players, DAT decks, etc.

The DM-24 incorporates a sampling frequency converter, allowing input from sources with a sampling frequency different from that of the DM-24.

The DM-24 can output audio data from both the XLR and the RCA connectors of each digital output at the same time.

Each of these output pairs can be used as the stereo mastering outputs, as paired buss outputs, as paired aux sends, or as the feed to the control room monitoring system.

The sampling frequency of the digital audio from these outputs is always the system sampling frequency of the DM-24.

### Synchronization and control connections

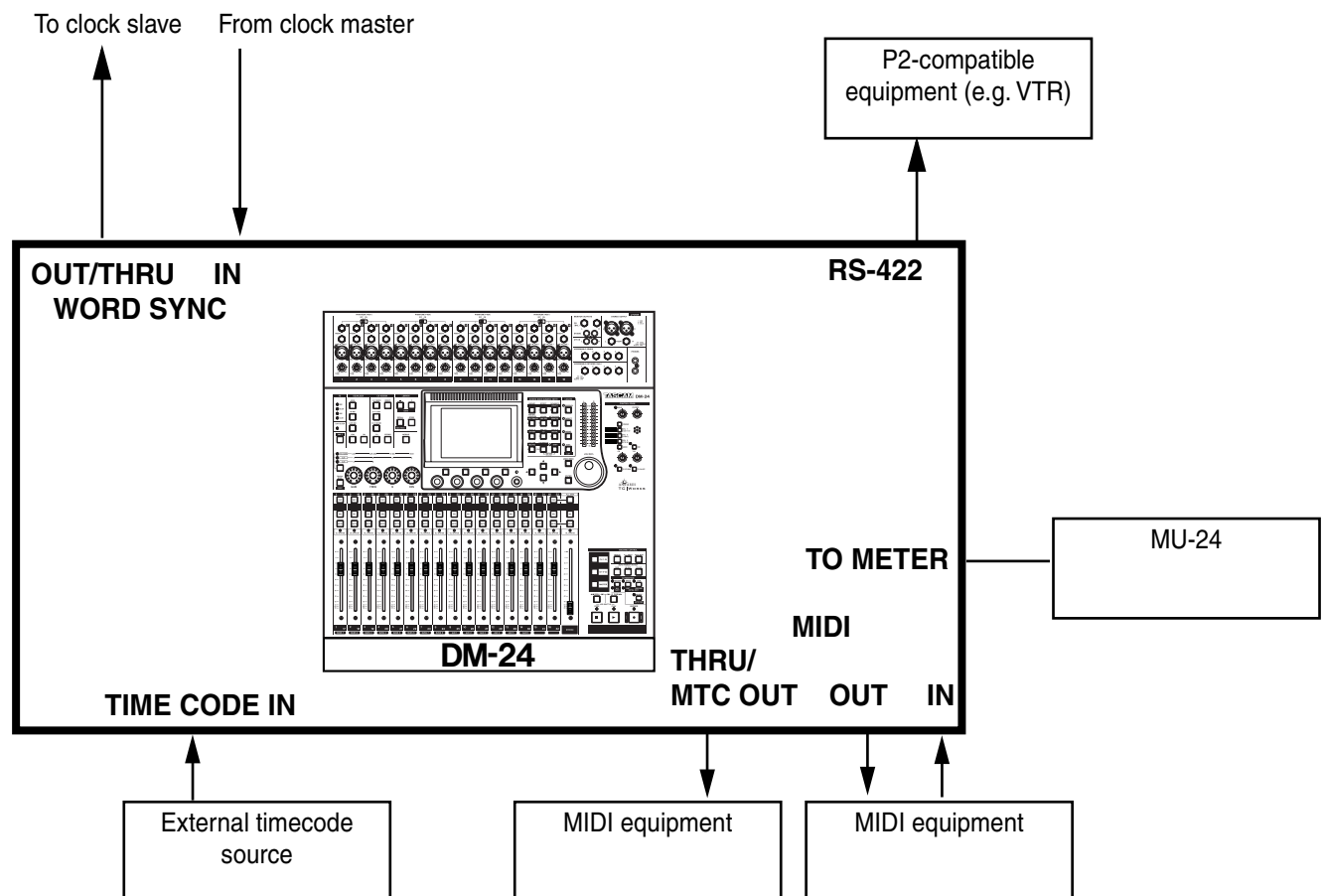

## 6 – Hookup—Synchronization and control connections

### Word sync clock connections

#### NOTE

*In every digital audio setup, there must be one, and only one, word sync source. If there is more than one source in a system, there is a risk of causing damage to the monitoring system (and your hearing).*

The DM-24 can act as either a word sync clock master or as a slave.

In the case of the DM-24 acting as a master for the system, make sure that the switch by the BNC word sync connectors is in the center position (75-ohm **IN** termination is **OFF**, and the DM-24 generates the word sync signal from the **OUT** terminal).

In the case of the DM-24 being a word sync clock slave, it is possible for the DM-24 to either retransmit

the word sync to other units, or to act as the last unit in the word sync chain.

When retransmitting the sync, set the switch to the left position (75-ohm **IN** termination is **OFF** and the **OFF/THRU** setting is set to **THRU**).

If the DM-24 is the last unit in the word sync chain, the switch should be in the right position (75-ohm **IN** termination is **ON**).

All input and output is at TTL level.

Select the word sync source using the **CLOCK** screen in the **DIGITAL** section (“**CLOCK** settings” on page 24).

#### NOTE

*It is not recommended that any ADAT unit is set up to be a word clock slave.*

### MIDI connections

Make these connections following the usual MIDI standards

See “MIDI” on page 95 for details of how the DM-24 uses MIDI.

Also see “**SYNC/TC**” on page 23 for further details of MTC operation.

### SMPTE/EBU timecode connections

SMPTE/EBU analog timecode is received at the **TIME CODE IN** connector on the rear panel

The timecode is needed when using the automated mix functions.

Note that the DM-24 does not output analog timecode, but can output MTC for use by other units.

See “**SYNC/TC**” on page 23 for details of setting up the DM-24 to use the timecode.

### Meter unit

The optional MU-24/DM meter unit may be connected to the **TO METER** connector.

Consult the documentation with the meter unit for full details of installation and using the meters with the DM-24.

### P2 connections

Devices which implement the P2 protocol can be controlled by the DM-24.

See “**Machine Control/Location**” on page 80 for full details of control of other devices using the DM-24.



The DM-24's modules are controlled by a series of screens which allow the viewing and control of the parameters which can be set for each module.

For the most part, modules have the same parameters available to them. If there are difference between module options, these are explained in the appropriate section.

There are four module screens, accessed using the “soft keys” by the PODs. These screens control the channel dynamics processing, EQ, the aux sends, and general setup parameters.

There is also a “common area”, which is always visible, regardless of the module screen currently visible.

The different parameters visible on each screen are given here:

Screen	Parameters
Common area	Dynamics switch, compressor insert, phase switch, assignable insert switch, buss assignment, EQ switch, EQ graph <sup>a</sup> , dynamics graph <sup>a</sup> , mute switch, fader, mute/fader grouping <sup>a</sup> , input source <sup>b</sup> , meter <sup>a</sup> , metering point, digital trim, pan

Screen	Parameters
DYNAMICS	Dynamics processor parameters
EQ	EQ parameters
AUX	Aux send levels, source select
SETUP	Channel source, gate switch, aux 1–2 source, compressor insert, compressor switch, assignable insert, assignable insert switch, phase, channel delay

a. Visible, but not editable

b. Editable on channels 1 through 24 only

On-screen controls are operated as explained in “User interface” on page 12 (the dial and cursor keys are used to navigate so that a control is highlighted, and the value changed with the PODs and the **ENTER** key).

### Selecting modules

To select a module for editing using these module screens, press the **MODULE** key (19) to place the unit in module editing mode, followed by the **SEL** key (49) of the module to be edited.

If two modules have been linked as a stereo pair, pressing the **SEL** key of either module of the pair will bring up the screen allowing control of both modules (see the section on “Linked modules” on page 60 for further details).

It is possible to reverse this order; that is, press the **SEL** key and then the **MODULE** key.

In addition, even if the **MODULE** key has not been pressed (the DM-24 is not in module editing mode), it is possible to configure the DM-24 so that pressing and holding the **SEL** key of a module for more than two seconds will automatically select that module's editing screen (“Select MODULE Return” on page 21).

It is also possible to select the module for editing (when the **MODULE** screen (or the **DYNAMICS** screen) is displayed) by touching the module's fader, rather than pressing the **SEL** key (“Fader Auto MODULE Select” on page 21).

# 7 – Module operations—Common area indicators and controls

## Common area indicators and controls

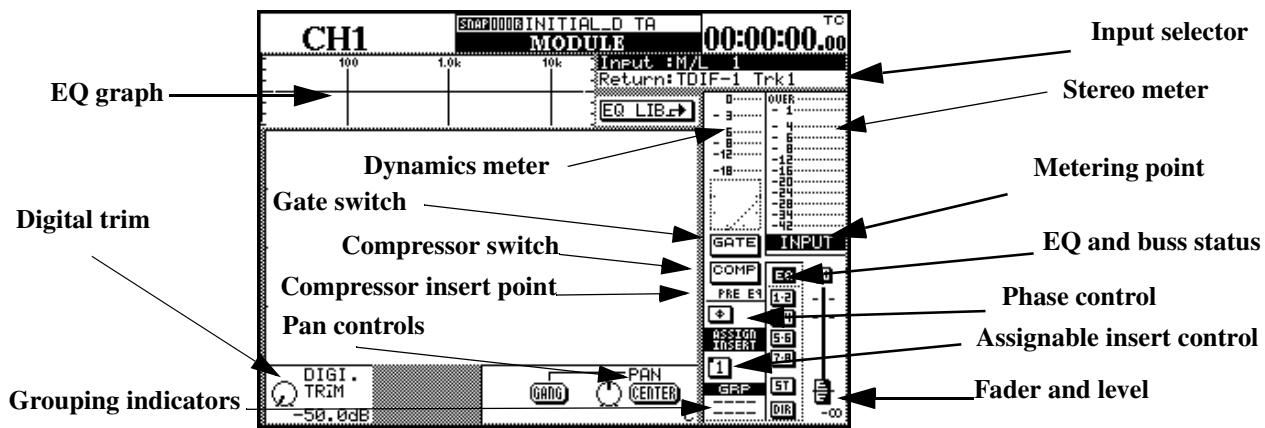

In addition to the parameters visible above, the common area also provides a way of viewing the current I/O assignment, together with a graphical view of the current EQ settings, as well as the current dynamics processor (with meter) and meter facilities.

### NOTE

Some of these parameters can be viewed and set globally for the whole console. See "Setting up the I/O" on page 36.

The on-screen controls available in the common area are:

### Dynamics controls

The exact controls and display vary, depending on what channel has been selected (see "Dynamics processors" on page 63 for full details of the availability of dynamics processors for the different modules of the DM-24):

**Gate/Expander** An on-screen button allows the gate/expander to be switched, with a gain reduction meter displayed.

**Compressor** An on-screen button allows the compressor to be turned on and off (**ENTER** key), with a dynamics graph. The gain reduction meter also applies to the compressor.

The appearance of this button changes, depending on what link option has been selected (see "LINK L->R" on page 64):

Link setting	Shown as
Link off	
Left channel acts as trigger	

Link setting	Shown as
Right channel acts as trigger	
Both channels act as triggers	

**Compressor insert point** The compressor can be inserted either pre- or post-EQ (channels). The master insert is pre-fader.

Simply press the **ENTER** key when PRE EQ or POST EQ is highlighted, to toggle between the two positions (the dial key acts as a cursor here).

**Dynamics meter** This meter shows the post-compressor effect of the dynamics processor assigned to the module.

A graphical display of the settings is also provided (with attack, knee point, compression ratio, hysteresis, etc. displayed).

## Other common controls and displays

**Digital trim and pan** There are also two other controls visible at the bottom of the screen—the digital trim and pan—above the soft key labels. These are dealt with below (“Digital trim control” on page 51 and “Pan control” on page 51).

**Phase switch** This on-screen switch reverses the phase of the input signal (use the **ENTER** key to toggle on and off).

In the case of linked pairs, each channel’s phase is independently reversible.

**Assignable inserts** If one of the assignable sends and returns has been assigned to this channel (two send/return pairs in the case of a linked pair), the insert can be turned on or off.

The status of the insert (pre- or post) is shown by the small “cutout” on the left of the on-screen button.

Pre-fader		Post-fader	
On	Off	On	Off

**Input/return assignments** The current assignments for this module, depending on whether it is being used as an input or return module, are shown. They cannot be changed from this screen. Use the fourth module (SETUP) screen (“Setup screen” on page 57) or the dedicated I/O setup to change these settings (“Setting up the I/O” on page 36).

**Meter** The on-screen meter gives a reading taken from the defined metering point, which is switchable here between the input, pre-fader and post-fader.

## Digital trim control

The digital trim control (POD 1 of the bottom row) allows the adjustment of the module level between -50dB and +10dB in 61 0.5dB steps.

## Pan control

The pan control is on the bottom row of the PODs (that is, move the cursor to the bottom row and use the PODs).

The pan control is controlled by POD 4. Hard left is represented by L, and hard right by R. The center position is represented by C, and there are 201 possible pan positions available.

**EQ and buss assignments** These buss assignments, together with the status of the EQ (on or off) are shown at the right of the screen.

In addition, the EQ response curve is shown at the top of the screen. If the EQ is disabled, this is “grayed out”, and is solid if the EQ is enabled.

### NOTE

*It is not possible to change the buss assignments or the EQ switching from here. Use the dedicated keys (to the left of the display screen) for this. Full details are in “Channel-to-buss assignments by channel” on page 41.*

**Fader section** The current fader position (which will almost always correspond to the physical fader position, except when automation motor control is turned off) as well as the mute status, is provided on-screen, as is the mute status of the module.

The exact numerical value of the level is also displayed here. This allows the fader to be “normalized” easily, as when the fader is at the zero position, the on-screen fader knob is reversed.

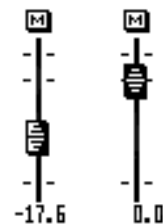

**Mute and fader groups** Any assignments to mute and fader groups are shown to the right of the screen.

These cannot be changed here (see “Grouping” on page 69 for full details).

See also “Global digital trim” on page 59.

To center the pan position easily, move the cursor to the CENTER on-screen button, and press **ENTER**.

If the channel is odd-numbered and is not part of a stereo linked pair, it can be ganged to the module to the right (even-numbered channels can be linked to odd-numbered channels to the left). If this GANG control is enabled (move the cursor to it and press

## 7 – Module operations—Common area indicators and controls

**ENTER**), the **CENTER** button described above will be disabled (grayed out).

### Balance controls for stereo linked pair

See “Linked modules” on page 60 for details of linked modules.

The balance controls in for linked modules are all on the bottom row of the **MODULE** screen. Move the cursor to the bottom row and use the **PODs** to change these parameters.

In the case of a stereo linked pair of modules, the **PAN** is replaced by a **BAL** control. Ganging is not possible, but a **CENTER** button is available, which centers the stereo signal.

**POD 2** is used to select the source. Either the left (odd-numbered) channel—**L MONO** or right (even-numbered) channel—**R MONO** or both together—**STEREO** can be selected. This allows the previewing of either channel individually, without having to unlink the channels

**POD 3** is used as an image width (**IMAGE**) control. This controls the width of the stereo spread of the two channels. The center position is labeled as **L+R MONO** and provides a pinpoint mixture of the two channels. Turning the control fully counterclockwise provides a full stereo (**STEREO**) image. Turning the control clockwise from the center reverses the left and right channels in the stereo image. Turning the control fully clockwise shows **REVERSE** on the screen.

#### NOTE

*In the Options screen (“Balance Level CENTER: 0dB” on page 21), the way in which the balance control level is modified at the center position can be changed between 0dB and a 3dB cut. Make this setting to reflect your preferred way of working.*

### Global pan

As well as individual pan settings, it is also possible to view and make the pan settings on a global basis.

- 1 With the **SHIFT** indicator unlit, press the **PAN/BAL SURROUND** key.
- 2 Continue to press the **PAN/BAL SURROUND** key until the following screen appears (or use soft key 2):

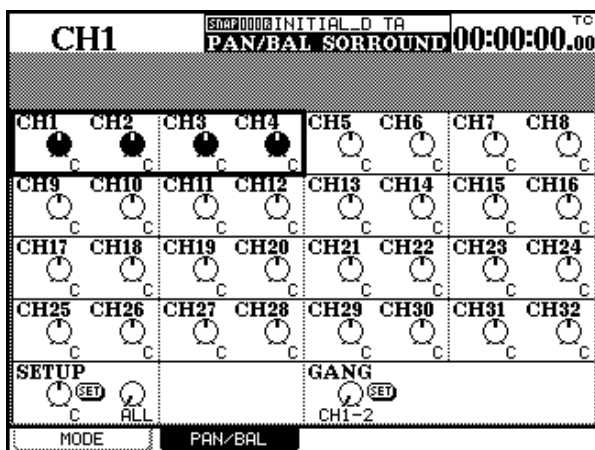

Use the cursor keys (and channel **SEL** keys) to navigate around the screen and set the pan or balance positions.

**Ganging** Note that ganged channels are displayed as ganged, but this setting cannot be changed at this position.

Move to the lower right of the screen and use **POD 1** to select a pair of channels to be ganged (linked channels cannot be selected here).

Use **ENTER** to make the gang setting (or break it if it has already been made).

**Setup** It is possible to apply the same pan/balance setting to groups of channels.

Move the cursor to the lower left of the screen, and use **POD 1** to set the master pan/balance setting.

The scope of the setting is determined using **POD 2**: choose between **ALL**, **EVEN** (even-numbered channels), **ODD** (odd-numbered channels), **1-8**, **9-16**, **17-24** or **25-32**.

Press **ENTER** to apply the **POD 1** setting and press **ENTER** again to confirm this when the popup appears (cancel with the cursor keys).

## Dynamics screen

In this screen, the dynamics processor functions of the modules can be controlled. There are three different types of dynamics processor that can be assigned: noise gates, expanders and compressors.

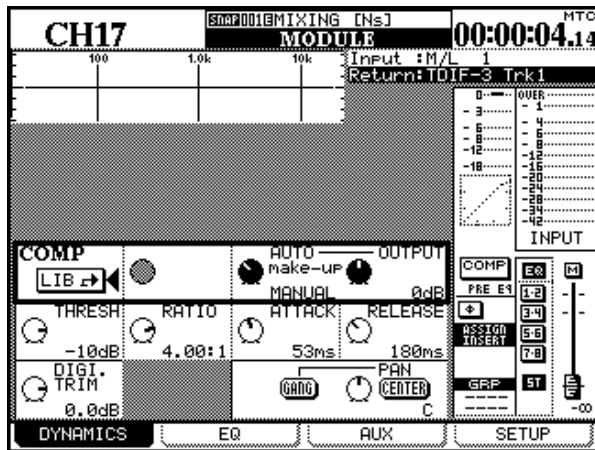

### NOTE

Gate and expander settings may not be made for input modules 17 through 32, as shown here.

Particular settings for these processors are stored in the DM-24 libraries and are recalled as necessary.

See “Library functions” on page 99 for full details of how settings are stored.

## Noise gate (GATE)

The purpose of a noise gate is to keep the input closed while the signal is below a threshold level, and open it when the signal rises above that level. In this

To recall one of these settings stored in the library:

- 1 Move the cursor to either of the LIB -> buttons on the display (either GATE (gate/expander) or COMP (compressor)).
- 2 Press the ENTER key.
- 3 This jumps to the library where the appropriate dynamics processor (either compressor or gate/expander) is stored.
- 4 Use POD 4 or the dial to scroll through the list of stored settings.
- 5 Use the fourth soft key (RECALL) to recall the highlighted setting.

**Only gates or expanders can be recalled to the GATE section, and compressors to the COMP section. The type of dynamics processor cannot be changed.**

### NOTE

The same procedure can be used to store the current settings to a library entry, using the STORE soft key rather than the RECALL key.

These procedures are explained in more detail in “Library functions” on page 99.

## Compressor

The compressors prevent loud transients from putting too much signal through the system.

Full details of the parameters are given in “Compressors” on page 67.

## Expander

The expander expands the dynamic range of the input signal.

Full details of the parameters are given in “Expander” on page 66.

## EQ

The principles of the EQ interface using the encoders are also explained in the section on “User interface” on page 12.

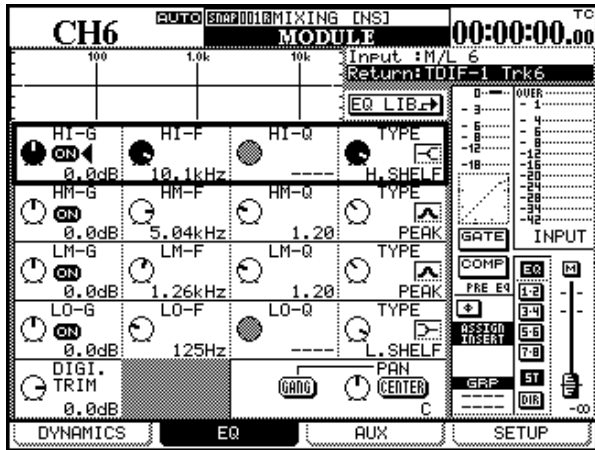

Briefly, when the module is selected, and the EQ screen is visible, the rotary encoders and PODs can be used to set up to four parameters of the selected EQ bands (gain, frequency, Q and type).

The EQ band to be edited in this way is selected using the **EQUALIZER** keys (16). The LEDs surrounding the encoders show the current status of the parameters, as explained in “Rotary encoders (ring LEDs)” on page 15.

See “Cursor follows EQ Band Key” on page 22 for details of setting up the DM-24 so that the on-screen cursor automatically follows the band selected using the **EQUALIZER** keys.

Alternatively, if the encoder function key (20) is pressed so that the **EQ GAIN** setting is selected (the indicator is lit), the gain of the four EQ bands of the selected modules can be changed using the encoders. Again, the relative gain is shown using the LEDs surrounding the encoders.

The PODs may also be used to make EQ settings, in conjunction with the cursor keys.

When a row is highlighted on screen, the PODs control the parameters in that row (in the screen above, the HI band is highlighted).

In addition, the cursor keys and data dial can also be used to make changes.

The response graph at the top of the screen changes as changes are made to the parameters. If the EQ is turned off for the module, this graph is grayed out (and of course, any changes made to the EQ cannot be heard!).

The EQ parameters are as following:

**On/off (all bands)** Each band can be turned on or off individually using the on-screen button beside the gain control (**ENTER** key).

If a band is turned off in this way, the gain of the band is automatically set to zero.

If the band is turned off, turning the gain encoder or gain POD for the band will automatically turn the band on again.

**Gain (all bands)** The maximum cut and boost (gain) on all bands is  $\pm 18$  dB.

Gain control is not possible when an EQ band type is set to notch filter, or high- or low-pass filter. In this instance, all LEDs of the appropriate encoder are turned off.

**Frequency range (all bands)** The frequency range for all bands is between 31 Hz and 19 kHz. The adjustment is made in semitone steps, giving a total of 112 different frequency positions across the range.

**Q (all bands)** When a band is set as a peak-type band, there are 24 Q settings available<sup>1</sup>: 8.65, 4.32, 2.87, 2.14, 1.71, 1.41, 1.20, 1.04, 0.92, 0.82, 0.74, 0.67, 0.61, 0.56, 0.51, 0.47, 0.44, 0.40, 0.38, 0.35, 0.33, 0.30, 0.28, 0.27.

When a band is set to non-notch filter or shelf mode, the Q cannot be set (the on-screen Q control is grayed-out) and all LEDs of the appropriate encoder are turned off.

**EQ band type** The EQ band type is always set using the fourth POD. The setting for the band is displayed on screen using the following symbols:

Peak	Shelf (low)	Shelf (high)	HPF	LPF	Notch
PEAK	L.SHELF	H.SHELF	HPF	LPF	NOTCH

**High band** The high band can be set as either a shelving (high shelf), peaking, or LPF type.

**High-mid band** The high-mid band can be set as either a peaking or a notch filter.

1. Q is defined as the width affected by a filter. The higher the Q value, the narrower the band affected by the filter.

**Low-mid band** The low-mid band can be set as either a peaking or a notch filter.

**Low band** The low band can be set as either a shelving (low shelf), peaking, or HPF type.

## EQ library

Commonly-used EQ settings can be stored into and recalled from the library. Full details of the library operation are given in “Library functions” on page 99, but briefly, moving the cursor to the on-screen EQ LIB button above the high band and pressing **ENTER** will jump to the EQ library.

- 1 Move the cursor to highlight the EQ LIB shown on the display.
- 2 Press the **ENTER** key.

- 3 This jumps to the library where the EQ settings are stored.
- 4 Use **POD 4 (or the dial)** to scroll through the list of stored settings.
- 5 Use the fourth soft key (**RECALL**) to recall the highlighted setting.

### NOTE

The same procedure can be used to store the current settings to a library entry, using the **STORE** soft key rather than the **RECALL** key.

## Aux sends

The aux sends are set using the screen accessed through the third soft key.

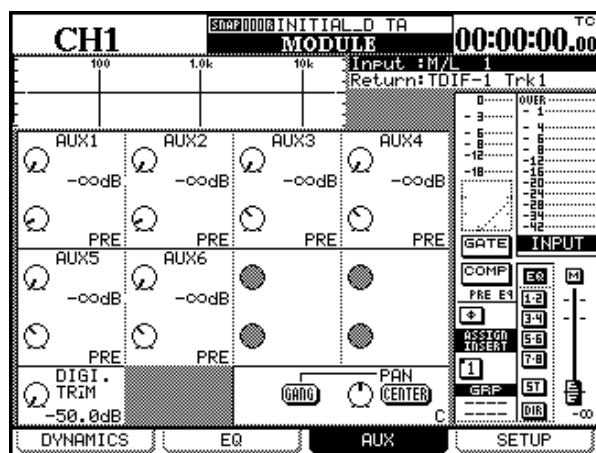

The PODs can be used to adjust the gain of the aux sends (first and third rows), as well as the pre-post settings of the sends (second and fourth rows).

In addition, if two aux sends have been linked together, the odd-numbered POD on the first and third rows of the screen is used to control the pan position of the signal sent to the stereo aux send.

In addition, as explained in the section on the user interface (“Encoders used as aux send controls” on page 17), the rotary encoders can also be used to set the send levels for the first four aux sends, and the last two aux sends for the selected channel. They can also be used to make the pan and balance settings when two aux sends are linked.

Aux sends may be linked as a pair (1&2, 3&4, 5&6). See “Linked modules” on page 60 for details of how they are linked.

The level of the aux sends is settable between  $-\infty$  dB and +10 dB (relative to nominal) in 127 steps.

Pan settings for stereo linked aux sends can be made from hard left (L) through center (C) to hard right (R)—127 steps.

Pre-post settings are made by turning the POD counterclockwise (PRE), and clockwise (POST).

Note that for aux sends 1 and 2, as well as pre-fader and post-fader selections, a **RETURN** setting is also available. This allows aux 1 and 2 to be used as the tape return path if channels 1 through 16 are being used as direct outputs.

## Aux sends (global)

In addition to the module screen, it is also possible to display a global aux screen to allow the viewing and setting of aux levels for many channels together.

- 1 With the **SHIFT** indicator off, press either **AUX 1-2**, **AUX 3-4** or **AUX 5-6**, for control of the appropriate aux sends.

The screen that appears depends on whether the selected aux sends have been linked together or not.

## 7 – Module operations—Aux sends

If they are not linked, a screen similar to the following appears:

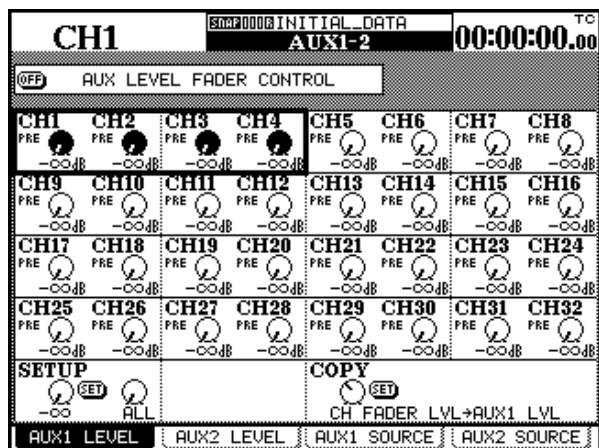

Using the cursor keys to move a cursor consisting of a box highlighting four on-screen controls around the screen. Alternatively, press the **SEL** key for a given channel to jump the cursor to the appropriate position on the screen.

The four controls correspond to the four PODs. If two channels are linked (as with channels 9&10 and 11&12 on this screen), only PODs 1 and 3 are active.

### NOTE

The rotary encoders, if selected to control aux send levels, are also valid controls for the selected channel or pair of channels.

**Fader control** At the top of the screen is a button which allows the faders to be used for setting the aux levels (as described in “Using the faders to change values” on page 14).

**Setup** A master level can be applied to selected channels by moving the cursor to the bottom left position setting the desired value with POD 1 and pressing **ENTER**.

The scope of the setting is determined using POD 2: either ALL, EVEN (even-numbered channels), ODD (odd-numbered channels), 1-8, 9-16, 17-24 or 25-32.

When **ENTER** is pressed, a popup message appears (Ch parameters setup?). Press **ENTER** again to confirm, or a cursor key to cancel.

**Copy** It is possible to copy the fader settings to the aux levels, or the other way round (aux levels to fader). This can be used as a starting point for mixes, setting up an initial monitor mix to mirror the stereo output, for example, which can then be adjusted as necessary.

Move the cursor to the bottom right of the screen, and use POD 1 to select the CH FADER LVL->AUXx LVL or the other way round (AUXx LVL->CH FADER LVL).

Press **ENTER** when the source/destination selection has been made, and press **ENTER** again to confirm the copy (cursor keys cancel).

### NOTE

See also “UTILITY copying” on page 62.

### Source (pre/post and SOURCE) settings

As the tabs at the bottom of the display show, there are four screens available through the soft keys (or repeated presses of the appropriate **AUX** key. The two LEVEL screens are identical. The SOURCE screens (aux 1 and 2) and AUXx PRE/PST (other aux sends) appear like this:

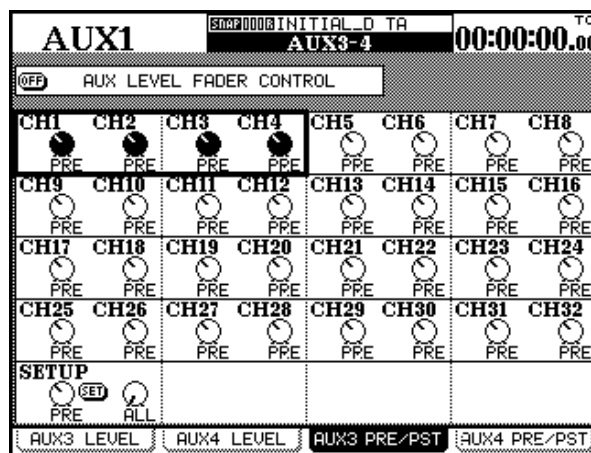

Use the cursor to navigate around the screen and the PODs to select either PRE or POST (pre-fader or post-fader aux sends). For aux sends 1 and 2, the RETURN source is also available for channels 1 through 16.

**Setup** A master pre-post setting can be applied to selected channels by moving the cursor to the bottom left position setting the desired value with POD 1 and pressing **ENTER**.

The scope of the setting is determined using POD 2: either ALL, EVEN (even-numbered channels), ODD (odd-numbered channels), 1-8, 9-16, 17-24 or 25-32.

**Linked aux sends** Two aux sends are linked in the same way as for channels—with the MASTER fader layer active press and hold the **SEL** key of one aux channel and press the **SEL** key of an adjacent send. Aux sends 1&2, 3&4, and 5&6 can be linked in this way. No other linking is possible.

When they are linked in this way, naturally they share the same level (the faders are linked) and any input to the linked aux send is panned.



# 7 – Module operations—Setup screen

**NOTE**

The appropriate preference must be set for the **SEL** keys to be used in this way (“ST Link by SEL key” on page 21).

Instead of four screens shared between the two separate aux sends, as described above, there are now three screens for the pair, as follows:

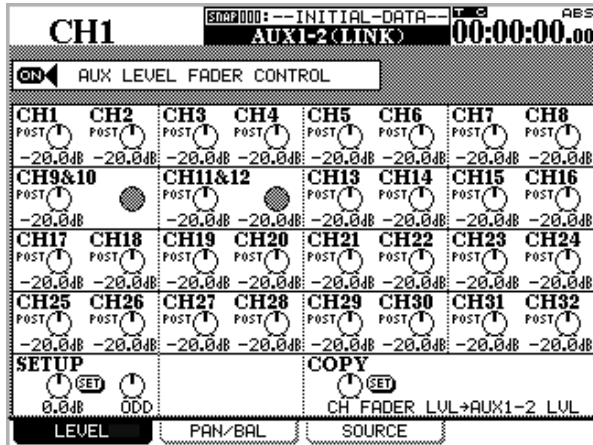

The linked level control screen is the same as for the mono (separate aux screens). Setup and copy facilities are available in this screen for global setups.

Note the AUX 1-2 (LINK) title at the top of the screen, though.

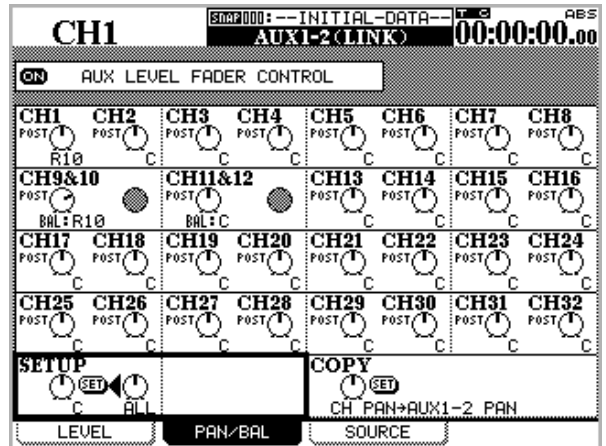

The linked aux pan screen allows the positioning of the pan position (or balance in the case of linked input channels) to the pair of aux sends.

There is a master setup at the bottom left, allowing all pan and balance settings (or a selected set) to be made identical, as well as a bidirectional copy facility, allowing channel-to-aux, as well as aux-to-channel, pan setting copying, as described earlier.

The faders can also be used to make the aux level settings, as described in “Using the faders to change values” on page 14.

The pre-post settings (SOURCE for 1-2, as this includes RETURN, and PRE/POST for 3-4, 5-6) are made in the same way as for unlinked aux sends.

## Setup screen

The setup screen acts almost as a channel “patch-bay”, allowing the configuration and readjustment of the components that make up a module.

At the top of the screen, a block diagram of the module’s current configuration is shown. As changes are

made, the block diagram is updated to reflect these changes

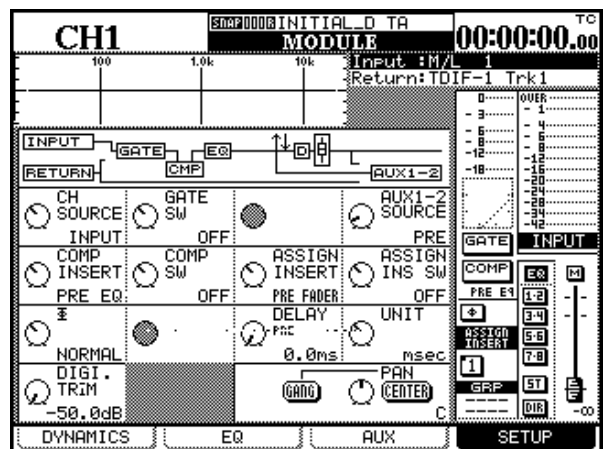

The above screen is the SETUP screen for channels 1 through 16. Channels 17 through 24, and 25 through

## 7 – Module operations—Setup screen

32 have slightly different screens, reflecting the different configuration:

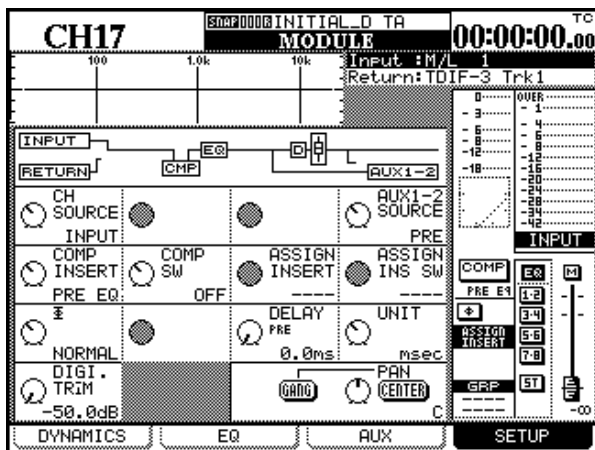

Channels 17 through 32 have no gate available.

The aux 1-2 sends are more limited in the choice of their source points (no return available)

Channels 25 through 32 have no channel digital delay available.

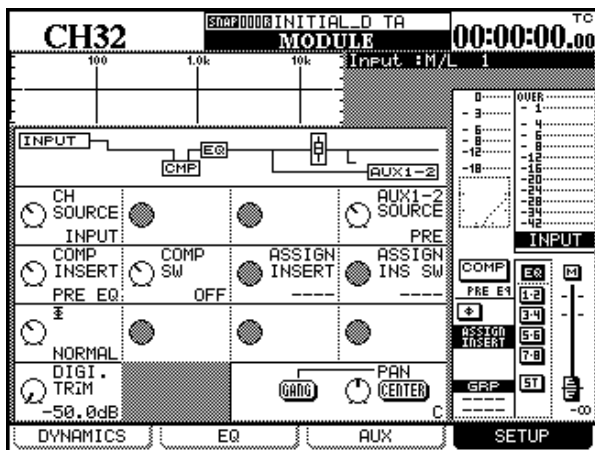

The controls available on these screens (through the PODs or through the cursor keys and data dial) are:

**Channel source (CH SOURCE)** This is a 2-way switch. Turning POD 1 (top row) counterclockwise selects the input (INPUT) source, and turning it clockwise selects the return (RETURN) source (channels 1 through 24 only). Both of the actual sources (input and return) are defined in the I/O screen, not here.

The display at the top left of the screen is updated, as is the block diagram.

**Gate switch (GATE SW)** This (POD 2) turns the gate (if available) on (clockwise) or off (counterclockwise). Channels 1 through 16 only.

### Aux 1 and 2 source (AUX 1-2 SOURCE)

This (POD 4) selects the source for the Aux 1 and 2 sends to be either pre-fader (PRE), post-fader (POST) or the return associated with the module (RETURN). This selection is available in this screen because these aux sends may be used effectively as studio monitor sends, and flexibility is therefore a useful feature here.

For channels 17 through 32, only the pre and post options are available here.

#### NOTE

*Note that even if aux sends 1 and 2 are unlinked, the settings of both are modified together using this control.*

**Compression insert (COMP INSERT)** This selects the position for the compressor insert (if assigned) to be either pre-EQ (PRE EQ, counterclockwise) or post-EQ (POST EQ, clockwise).

**Compressor switch (COMP SW)** This switch (POD 2) turns the compressor (if assigned) either off (OFF, counterclockwise) or on (ON, clockwise).

**Assignable insert position (ASSIGN INSERT)** This (POD 3) allows the positioning of the assignable insert in the module chain. There are two positions, pre-fader (PRE FADER) and post-fader (POST FADER).

**Assignable insert switch (ASSIGN INS SW)** This switch (POD 4) allows the switching of the assignable insert loop (at the position determined by the previous switch) as either on (ON, clockwise) or off (OFF, counterclockwise). These controls are disabled if no assignable loop has been assigned to the channel.

**Phase switch ( $\Phi$ )** This (POD 1) reverses the phase of the input when turned clockwise (REVERSE), otherwise, the phase of the signal is normal (NORMAL).

For stereo linked channels, PODs 1 and 2 are used for controlling the phase of the left (odd) and right (even) channels respectively.

**Digital delay time (DELAY)** The channel can be delayed by up to 16,383 samples (the maximum in high sampling frequency is 32,767 samples). This is equivalent to 341.2 milliseconds at 48k or 96k sampling frequencies, or 371.5 milliseconds at 44.1k or 88.2k sampling frequencies.

## 7 – Module operations—Digital trim and delay (global)

Channel delay is only possible on modules 1 through 24. See also “Global digital delay” on page 59.

**Digital delay units (UNIT)** Choose either samples (SAMPLE) or milliseconds (ms) as the unit in which channel digital delay is measured.

See also “Global digital delay” on page 59.

### Digital trim and delay (global)

Two dedicated screens allow the viewing and setting of the digital trim and delay parameters.

#### Global digital trim

- 1 With the **SHIFT** indicator lit, press the **DIGI. TRIM/DELAY** key until the following screen appears:

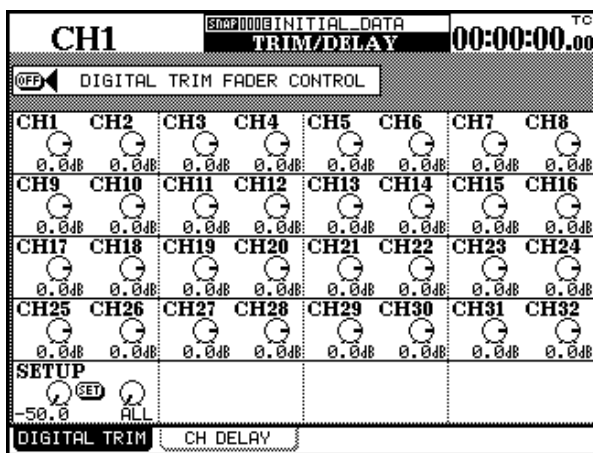

Use the cursor keys and the **SEL** keys to navigate the cursor round the screen.

Use the PODs to set the amount of digital trim from -50.0dB to +10.0dB in 0.5dB steps.

Linked channels share the same digital trim setting.

**Fader control** At the top of the screen is a button which allows the faders to be used for setting the trim levels (as described in “Using the faders to change values” on page 14).

**Setup** A master trim can be applied to selected channels by moving the cursor to the bottom left position setting the desired value with POD 1 and pressing **ENTER**.

The scope of the setting is determined using POD 2: either ALL, EVEN (even-numbered channels), ODD (odd-numbered channels), 1-8, 9-16, 17-24 or 25-32.

When **ENTER** is pressed, a popup message appears (Ch parameters setup?). Press **ENTER** again to confirm, or a cursor key to cancel.

#### Global digital delay

- 1 With the **SHIFT** indicator lit, press the **DIGI. TRIM/DELAY** key until the following screen appears:

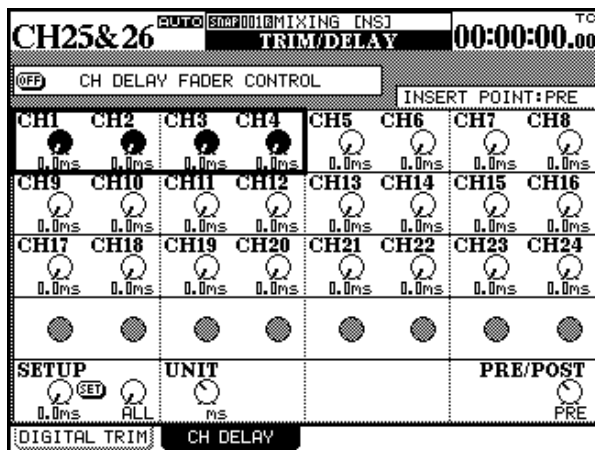

Use the cursor keys and the **SEL** keys to navigate the cursor round the screen.

Use the PODs to set the amount of digital delay up to 16,383 samples (the maximum in high sampling frequency is 32,767 samples). This is equivalent to 341.2 milliseconds at 48k or 96k sampling frequencies, or 371.5 milliseconds at 44.1k or 88.2k sampling frequencies.

This delay can be used to compensate for signal processing, etc. and can be applied either before or after the fader. It is available for channels 1 through 24 only.

#### NOTE

*This is not a delay or echo effect as provided by the internal effectors.*

Linked channels share the same digital delay setting.

## 7 – Module operations—Linked modules

**Unit** Change the delay units between samples (SP) and milliseconds (ms) using POD 3 at the bottom left of the screen.

**Fader control** At the top of the screen is a button which allows the faders to be used for setting the delay (as described in “Using the faders to change values” on page 14).

**Setup** A master delay setting can be applied to selected channels by moving the cursor to the bottom left position setting the desired value with POD 1 and pressing **ENTER**.

The scope of the setting is determined using POD 2: either ALL, EVEN (even-numbered channels), ODD (odd-numbered channels), 1-8, 9-16 or 17-24.

When **ENTER** is pressed, a popup message appears (Ch parameters setup?). Press **ENTER** again to confirm, or a cursor key to cancel.

**PRE/POST** The delay can be applied pre-or post-fader. This setting is made globally, for all 24 channels and cannot be made individually.

Move the cursor to the bottom right of the screen, and turn POD 4 to select between PRE and POST fader operation.

---

### Linked modules

---

Modules which may be linked in stereo pairs must be adjacent to each other, with the odd-numbered module of the pair being the lower-numbered. That is, modules 3 and 4 may be linked, but modules 4 and 5 may not.

When modules have been linked, pressing the **SEL** key of one module of the pair selects the pair.

The parameters and settings which are shared by the pair are:

**Channels** Digital Trim, Gate (only Ch1-16), Compressor, EQ, Aux1-6 (Pre/Post, Level), Mute, Fader Level, Assign, Delay, Solo (On/Off, Defeat setup), Input select, Aux1-2 select, Compressor insert point, Assignable send/return, Grouping.

**Master modules** Compressor, Mute (except Stereo), Fader Level, Assign.

---

### Linking and unlinking modules

Modules may be linked either by means of the linking screen (see the section on groups for details) or by means of the **SEL** keys if the option has been set (“ST Link by SEL key” on page 21).

- 1 Press and hold down the SEL key of one of the pair of modules to be linked.**
- 2 Press the SEL key of the other module in the pair to be linked.**

To unlink modules, repeat the process (press and hold down one **SEL** key of the pair, and press the other **SEL** key).

#### **NOTE**

*When two faders are linked, you may find that moving both faders together produces a feeling of stiffness in the controls, as each fader is constantly attempting to keep up with the other. We suggest that in the case of two linked faders, you only move one fader. Even if the movement of a fader may seem a little rough or jerky when you are moving the other fader of the pair, it is only the physical control that exhibits this symptom. The change in the actual signal level of the second channel will be as smooth as the fader movement that you are making.*

## Stereo linking (global)

There is a global screen which allows the viewing and setting of stereo links:

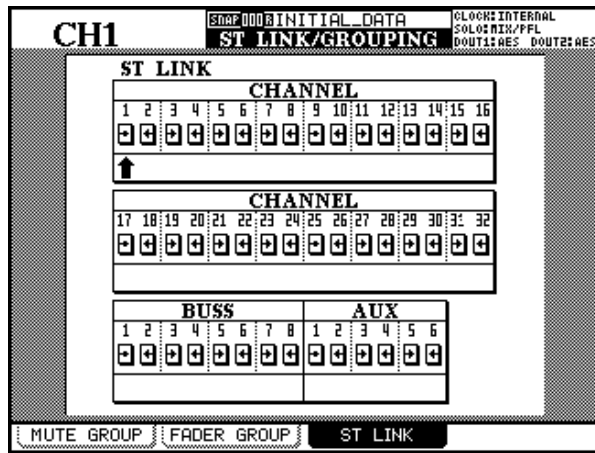

To use this screen:

- 1 With the **SHIFT** indicator lit, press the **LINK/GRP** key.
- 2 Press the **LINK/GRP** key until the **ST LINK** screen appears (or soft key 3).

- 3 Use the **cursor keys** or the channels' **SEL** keys to navigate round the screen (the cursor is an upward-pointing arrow – in this screen it is highlighting channel 3).

Linked channels and unlinked channels are shown in the following way:

Linked	Unlinked
ST LINK	↕ ↕

- 4 Press **ENTER** to make a stereo link from unlinked channels, or to break the link of linked channels.

Note that busses as well as aux sends can be stereo linked using this screen. When they are linked, the compressor settings, assignments, muting and fader levels are linked.

### NOTE

The grouping patterns ("Grouping" on page 69) may change when channels are linked or unlinked. Recheck the grouping patterns after making or breaking these stereo links.

## Screens for linked modules

The screens controlling stereo linked modules differ from unlinked modules in the following ways:

**Phase** Phase can be set individually for both modules of the pair

**Pan** Changes to balance, and an image width control is added.

The balance control can be centered, but naturally there is no gang option.

POD 3 is used as an image width (**IMAGE**) control. This controls the width of the stereo spread of the

two channels. The center position is labeled as **L+R MONO** and provides a pinpoint mixture of the two channels. Turning the control fully counterclockwise provides a full stereo (**STEREO**) image. Turning the control clockwise from the center reverses the left and right channels in the stereo image. Turning the control fully clockwise shows **REVERSE** on the screen.

**Mono switch (MONO SW)** The mono switch is situated in the bottom row (POD 2). It allows the selection of either channel of the stereo pair (**L MONO** or **R MONO**), as well as the normal (**STEREO**) position.

## UTILITY copying

This screen allows the aux send levels and pan settings for a group of channels to be set up to mirror the settings made on the channel faders, and the other way around. This may be useful when setting up a studio monitor mix, for example, and the levels and pans of the aux sends used for the monitor mix should initially be set to the same as the channels.

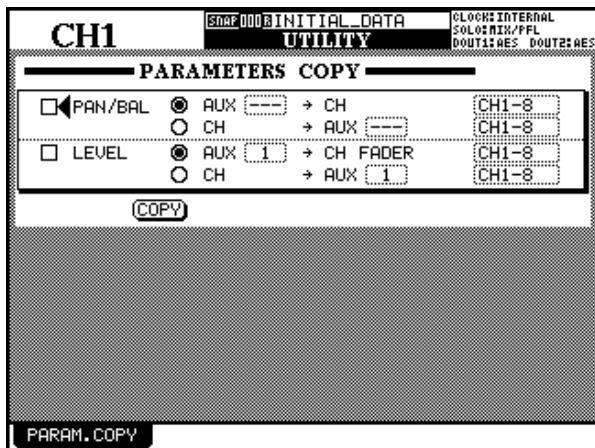

The screen above allows these copies to be made from one screen.

- 1 With the **SHIFT** indicator lit, press the **UTILITY** key.

There is only one screen, as shown here.

- 2 Check either of the two checkboxes (PAN/BAL and/or LEVEL) to select the settings to be copied.

- 3 In either of the two boxes, select either the **AUX -> CH** or the **CH -> AUX** setting radio button.

Naturally, it is not possible to select both in the same box, though it is possible to select CH -> AUX in one box and AUX -> CH in the other.

- 4 Select the source and the destination parameters as explained here.

For pan/balance settings, aux sends must be linked to be used as either sources or destinations. It is not possible to select individual aux sends here.

The aux sends are selectable individually or as linked pairs as sources or destinations for level copying.

Channels are divided into blocks of eight: 1-8, 9-16, 17-24, 25-32 and ALL. Individual channels cannot be selected.

- 5 Move the cursor to the on-screen **COPY** button and press **ENTER**. A confirmation popup message appears.

- 6 Press **ENTER** again to confirm the copy, or a cursor key to cancel.

If neither of the checkboxes is checked when you press the **COPY** button, an error message is displayed.

The DM-24 includes dynamics processors, which may be assigned as required throughout the mixing chain.

These high-quality processors are all digital and include compressors, gates and expanders.

The processor list comprises:

- Sixteen gate or expander units available for the first 16 input channels

- Thirty-two compressor units for channels 1 through 32
- Six assignable output compressors for the aux sends, the buss masters and the stereo outputs

In addition, the placement of the compressors may be controlled so that they affect the signal at different points in the processing chain.

### Turning the processors on and off

When there is more than one processor available for a module (that is, for channels 1 through 16), the module screen is used to select whether the gate or the expander is on or off.

In all module screens, the compressor can be turned on and off (channels 1 through 16 also allow the independent turning on and off of the gate/expander).

In the DYNAMICS screen (channels 1 through 16), the gate or expander can be turned on and off, and the compressor can also be turned on and off independently.

### DYNAMICS (input channels 1–16)

The screen accessed by the **DYNAMICS** key shows the settings for the currently selected input channel (as shown by the **SEL** indicator).

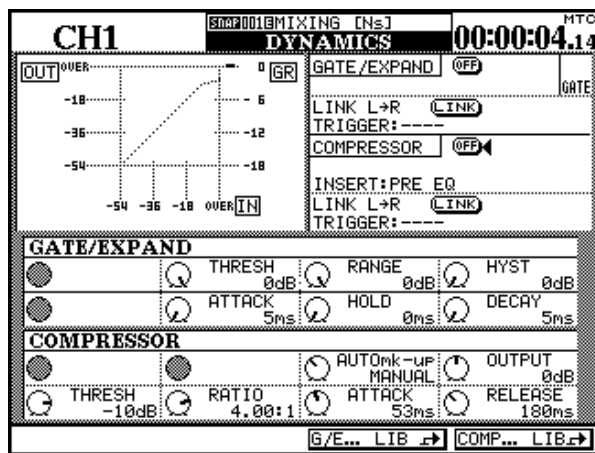

If the selected channel is linked as part of a stereo pair, the settings affect both channels.

Pressing the **SEL** key of another channel (or channels) will bring up the dynamics settings for that channel.

### Selecting a gate or an expander

The processors are selected using the library function. If a template, preset or user library entry which corresponds to a noise gate is selected from the gate/expander library, the gate parameters appear on screen.

If, on the other hand, an expander library entry is selected, the expander parameters will appear on screen.

When the DYNAMICS screen is shown, to change from a gate to an expander, or *vice versa*, use the G/E... LIB soft key to bring up the library screen, and recall a library entry of the appropriate type.

## 8 – Dynamics processors—DYNAMICS (channels 17–32)

### “Master” settings

The “master” settings for channels 1 through 16, affecting the dynamics processors, and accessed (by means of on-screen “on-off switches”) by moving the cursor to the appropriate on-screen control and pressing **ENTER**, are:

**GATE/EXPAND** This allows the gate or expander to be turned on or off for the selected channel.

**LINK L->R** This allows triggering of two gates or expanders by a common trigger signal.

#### NOTE

*The linking of the gates or expanders cannot be turned off when two channels have been linked. The above screen display shows L=R when the channels are linked.*

**Trigger source** (TRIGGER) is only valid when two gates or expanders are linked. This option (selected using **ENTER** key, the dial and **ENTER** key again) allows the triggering for both processors to be initiated by L-ch (left channel), R-ch (right channel) or BOTH (both channels act as triggers—in other words, the first channel to be triggered will automatically activate the second channel’s processor).

**Compressor** This allows the compressor to be turned on or off for the selected channel.

**Insert point** (INSERT) allows the compressor to be inserted either pre-EQ or post-EQ. Move the cursor to this field and use the **ENTER** key to change this setting.

**LINK L->R** This allows triggering of two compressors by a common trigger signal.

#### NOTE

*The linking of the compressors cannot be turned off when two channels have been linked. The above screen display shows L=R when the channels are linked.*

**Trigger source** (TRIGGER) is only valid when two compressors are linked. This option (selected using **ENTER** key, the dial and **ENTER** key again) allows the triggering for both processors to be initiated by L-ch (left channel), R-ch (right channel) or BOTH (both channels act as triggers—in other words, the first channel to be triggered will automatically activate the second channel’s processor).

### Soft keys (library)

There are two soft keys at the bottom of this screen. The first jumps to the gate/expander library, and the second jumps to the compressor library. In this way, it is easy to store the current settings to a library entry for future use, or to use the library to recall a previ-

ously-stored set of settings for the current session, or in the case of channels 1 through 16, to change between gate and expander settings.

See “Library functions” on page 99 for full details.

## DYNAMICS (channels 17–32)

The DYNAMICS screen shown when a channel between 17 and 32 is selected differs from the screen when a channel between 1 and 16 is selected:

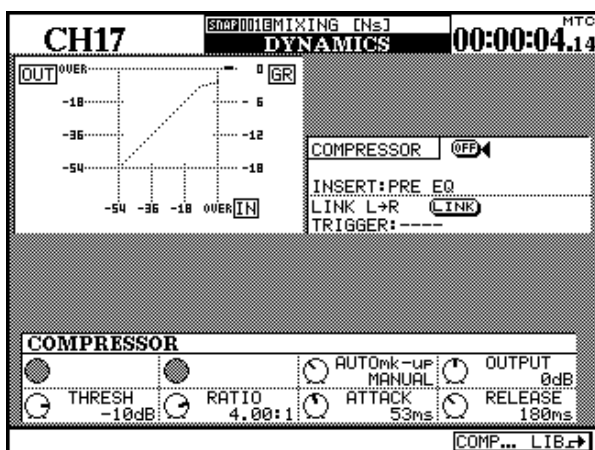

No expander or gate is available for these master screens. Any on-screen controls associated with these processors are therefore unavailable. This includes the soft keys—only the compressor library is available from these screens.



## DYNAMICS (master channels)

The screen accessed by the **DYNAMICS** key when a master channel (an aux send, a buss or the stereo master) is selected is slightly different from the screen displayed when a channel 1–16 is selected:

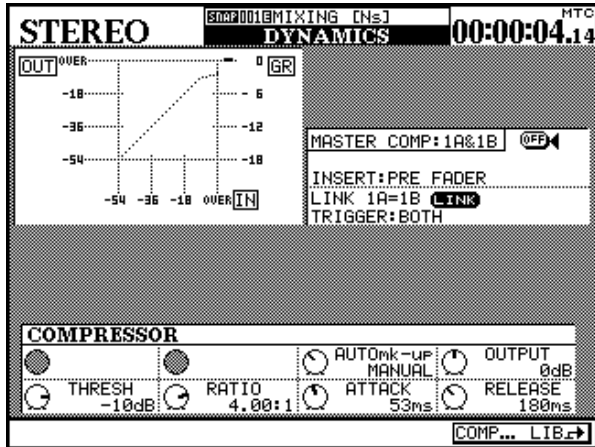

The screen above shows two linked aux sends (1 and 2), but the same principle applies to buss masters as well as the stereo master.

Note that the following features are different from the channel 1–16 dynamics screens:

**No expander or gate** available for these master screens. Any on-screen controls associated with these processors are therefore unavailable. This includes the soft keys—only the compressor library is available from these screens.

**Insert point** The insert point is fixed to pre-fader.

**Linking** The way in which the links are labeled is different for master modules. Instead of the channels being referred to as left and right, they are referred to as 1 and 2 (“left” and “right” do not have any real meaning in these cases).

## Assigning processors to master channels

The assignment of stereo compressors to up to three master channels is done using the I/O display ASSIGN SECT. sub-screen

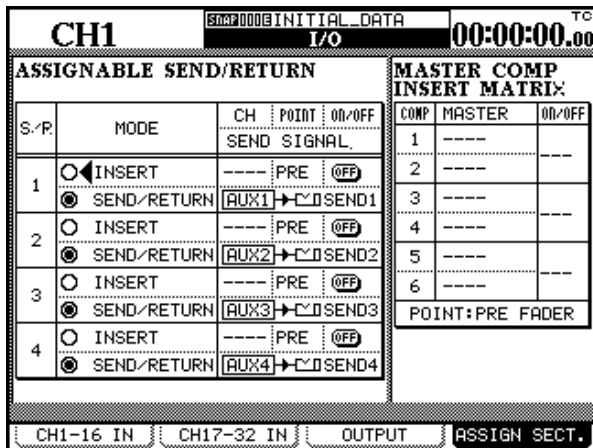

Use the fourth soft key to bring up the master assignment section.

Move the cursor to the second column (MASTER COMP INSERT MATRIX), and use the dial to assign the possible master channels (confirm with **ENTER**).

### NOTE

The stereo master counts as two channels, as shown in the sample screen here.

## 8 – Dynamics processors—Dynamics diagram

### Dynamics diagram

The following display provides a graphical representation of the compressor settings, as shown below. As

the signal is fed through the compressor, bargraph meters are shown on the appropriate scale:

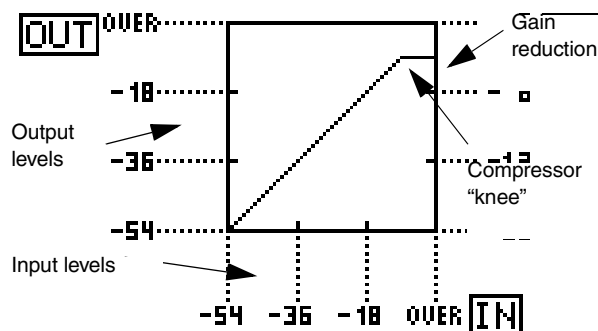

### Gates/expanders

The following parameters affect the gate and expander, if these have been assigned to the selected channel.

#### Gate

**Threshold** (THRESH), controlled by the POD 1 knob, allows the setting of the threshold at which the gate will open. Variable from -80dB to 0dB in 1 dB steps.

**Range** (RANGE), controlled by the POD 2 knob, sets the gate range, from 60dB to 0dB in 1dB steps.

**Hysteresis** (HYST), controlled by the POD 3 knob, from 0dB to 24dB in 1dB steps.

**Gate attack time** (ATTACK), controlled by the POD 1 knob on the last row. Variable from 0ms to 125ms in 1ms steps.

**Gate hold time** (HOLD), controlled by the POD 2 knob on the last row. Variable from 0ms to 990ms in 100 steps.

**Gate decay time** (DECAY), controlled by the POD 3 knob on the last row. Variable from 50ms to 5.0s.

From 5 ms to 200ms, the steps are 5 ms apart; from 200ms to 300ms, the steps are 10ms apart; from 300ms to 500ms, the steps are 20ms apart; from 500ms to 1.00s, the steps are 50ms apart; from 1.00s to 3.00s, the steps are 0.1s apart; and from 3.00s to 5.00s the steps are 0.2s apart.

#### Expander

**Threshold** The threshold of the expander function, from -48dB to 0dB, in 1 dB steps.

**Ratio** The ratio of the original signal relative to the expanded signal. Values are 1:1, 1:2, 1:4, 1:8, 1:16, 1:32, 1:64.

**Attack** The attack time of the expansion effect. From 0ms to 125ms in 1ms steps.

**Release** The release time of the expansion effect. From 5ms to 5.00 seconds.

From 5 ms to 200ms, the steps are 5 ms apart; from 200ms to 300ms, the steps are 10ms apart; from 300ms to 500ms, the steps are 20ms apart; from 500ms to 1.00s, the steps are 50ms apart; from 1.00s to 3.00s, the steps are 0.1s apart; and from 3.00s to 5.00s the steps are 0.2s apart.

## Compressors

The 32 channel compressors and the six assignable output compressors all have the following parameters which may be set. The controls here refer to the controls on the DYNAMICS screen:

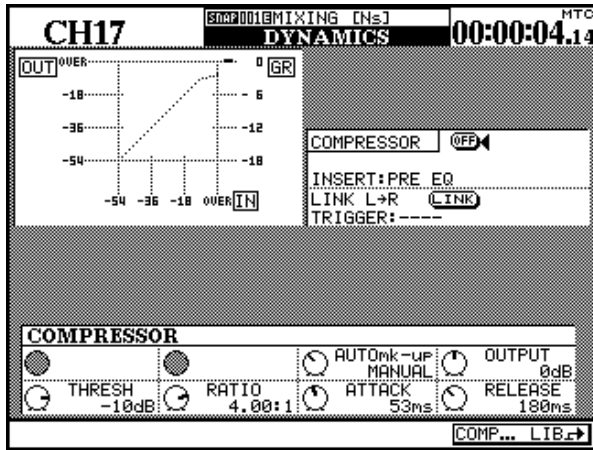

**Threshold (THRESH)**, controlled by the POD 1 knob, and variable from -48dB to 0dB in 1 dB steps.

**Compression ratio (RATIO)**, controlled by the POD 2 knob, and variable from 1:1 to ∞:1 (infinite compression).

The steps are as follows: 1.00:1, 1.05:1, 1.11:1, 1.18:1, 1.25:1, 1.33:1, 1.43:1, 1.54:1, 1.67:1, 1.82:1, 2.00:1, 2.22:1, 2.50:1, 2.86:1, 3.33:1, 4.00:1, 5.00:1, 6.67:1, 10.0:1, 20.0:1, ∞:1.

**Attack time (ATTACK)**, controlled by the POD 3 knob, and variable from 0ms to 125ms in 1ms steps.

**Release time (RELEASE)**, controlled by the POD 4 knob, and variable from 5ms to 5.0s in 100 steps.

From 5 ms to 200ms, the steps are 5 ms apart; from 200ms to 300ms, the steps are 10ms apart; from 300ms to 500ms, the steps are 20ms apart; from 500ms to 1.00s, the steps are 50ms apart; from 1.00s to 3.00s, the steps are 0.1s apart; and from 3.00s to 5.00s the steps are 0.2s apart.

**Auto make-up (AUTOMK-up)**, controlled by POD 3 used as a switch. This is used if the compression settings have resulted in gain reduction.

**Output gain (OUTGAIN)**, controlled by the POD 4 knob on the last row (grayed out if the auto make-up above is on). Variable from -20dB to +20dB in 1 dB steps.

## Preset library entries

The following preset entries are provided either to be used “as-is”, or to be used as templates or starting points for experimentation.

These library entries are read-only (marked with an inverse R on the display), and may not be overwritten. However, it is possible to load the entries, edit

the parameters, and then store them to a different library entry.

As always, there are no hard and fast rules as to what “works”. Feel free to use the settings in a variety of contexts and change them as seems appropriate to you.

## Compressors

Program Number	Name	Comment
000	Sample Snare	For use with snare drums
001	Slap bass	For use with slap-type bass inputs
002	Wood bass	For use with upright bass (double-bass or contra-bass)
003	Synth.Bass 1	For use with synthesized bass lines
004	Synth.Bass 2	For use with synthesized bass lines
005	Acoustic Guitar	To be used with acoustic guitars (nylon or steel-strung)
006	Ele.Guitar 1	For use with electric guitars
007	Ele.Guitar 2	For use with electric guitars
008	Ele.Guitar 3	For use with electric guitars
009	Brass	Effective with brass (horn) sections, etc.
010	Vocal 1	Use with vocal lines

## 8 – Dynamics processors—Preset library entries

<b>Program Number</b>	<b>Name</b>	<b>Comment</b>
011	Vocal 2	Use with vocal lines
012	Total Comp 1	Overall compressor setting
013	Total Comp 2	Overall compressor setting
014	Total Comp 3	Overall compressor setting
015	Post Pro.1	Useful in post-production environments
016	Post Pro.2	Useful in post-production environments
017	Narration	For the spoken word

### **Gates/Expanders**

<b>Program Number</b>	<b>Name</b>	<b>Comment</b>
000	Noise Gate 1	General noise gate setting
001	Noise Gate 2	General noise agate setting
002	Light Expander	An expander setting which is not too strong
003	Slow Expander	A slower expander setting

The DM-24 provides the ability to group channels in either fader or mute groups or both.

Note the following points with regard to the use of these groups:

Up to eight groups of each type may be used.

The pattern of the mute groups can be copied to the fader groups, so that the two group sets are identical.

A channel cannot be a member of more than one group of each type. In other words, it can be a member of only one fader group (or of no fader groups) and/or only one mute group (or of no mute groups).

In a group (whether fader or mute) there is always one channel which is referred to as the “master” channel. This channel sets the status for all the other “slave” channels in the group. For a mute group, this

means that the slave channels echo the mute status of the master channel. For a fader group, this means that moving the fader of the master channel will move the faders and alter the levels of the other channels in the group.

A “slave” channel in a group can be operated independently of the other channels in the group.

In addition to channels being members of the groups, groups can also be members of groups, allowing hierarchical “group layers” to be created. Fader groups can only be members of other fader groups, and mute groups can only be members of other mute groups.

The grouping screen includes a linking sub-screen, and this is covered in “Linked modules” on page 60.

## Mute groups

The two grouping screens (for fader grouping and mute grouping) are similar. This is the mute group screen.

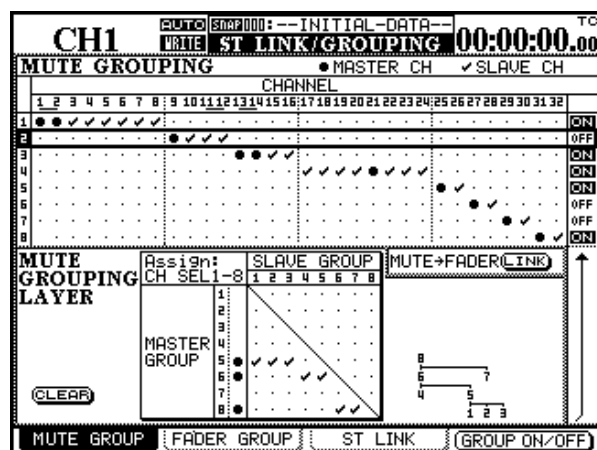

As the name suggests, mute groups allow the channels to be grouped together in such a way that pressing the **MUTE** key of the master channel of a mute group affects the mute status of all the other (slave) channels in the group.

Slave mute may be turned on or off independently of the other mutes in the group. Groups are shown as horizontal rows in the matrix in the upper part of the screen. The 32 channels are shown as columns.

If a row (group) has no check marks or large “bullet” dots in it, no channels have been assigned to that group.

To assign a channel to a group, use the **▲** and **▼** cursor keys or dial to move the cursor to the appropriate row.

If any channels have previously been assigned to the group, the **SEL** key of the master channel flashes when the group is selected, and the **SEL** keys of any slave channels light.

### NOTE

*It may not always be possible to see the flashing **SEL** key indicating a group master when you select a group on screen, as the master channel may be in an inactive fader layer.*

Press the unlit **SEL** key of any channel to assign the channel to the group.

If the channel is the first one to be assigned to the group, the symbol changes to a large bullet point, showing that it is the master channel of the group and the **SEL** indicator flashes.

If the channel is assigned to a group and it is not the first channel in the group, it is shown with a check mark to show that it is a slave channel, and the **SEL** indicator lights.

If a channel has already been assigned to a group as a slave and that group is currently selected, pressing the **SEL** key unassigns it from the group.

If a channel has already been assigned to a group as a master and another group is currently selected, pressing the **SEL** key to turn the channel into a slave channel brings up a warning message (Re-assign mute grouping?), and pressing **ENTER** reassigns the group. Any of the cursor keys may be used as “no” or “escape” keys here.

## 9 – Grouping—Fader groups

If a channel has already been assigned to a group as a master, pressing the **SEL** key clears the whole group. A popup message appears (Clear this mute grouping?),

and pressing **ENTER** clears the group. Any of the cursor keys may be used as “no” or “escape” keys here.

### Turning groups on and off

When a group is highlighted on screen (the cursor box surrounds it), either use the fourth soft key or the

**ENTER** key to turn the group functionality on or off. This does not clear the group settings.

### Copying mute settings to the faders

At the right of the display, about halfway down the screen, there is an on-screen LINK button.

When this button is off, it is labeled MUTE>FADER.

Moving the cursor to this button and pressing **ENTER** brings up a popup asking whether a link should be made: Grouping link(Mute -> Fader) (**ENTER** for yes, cursor keys for no).

This transfers the mute groupings to the fader groupings (that is, the fader group settings become identical to the mute group settings). This is a “live link”—when changes are made to the mute groups, they are echoed in the fader groups and the other way round.

The button is now labeled MUTE=FADER and is shown in inverse, showing that the link is active.

Pressing the **LINK** button in either the mute or the fader group screens deactivates the link.

## Fader groups

As the name suggests, fader groups allow the channels to be grouped together in such a way that moving the master fader of a group affects the fader level of all the other (*slave*) faders in the group.

Slave faders may be moved independently of the other faders in the group.

To assign a channel to a group, use the ▲ and ▼ cursor keys (or the dial) to move the cursor to the appropriate row.

If any channels have previously been assigned to the group, the **SEL** key of the master channel flashes when the group is selected, and the **SEL** keys of any slave channels light.

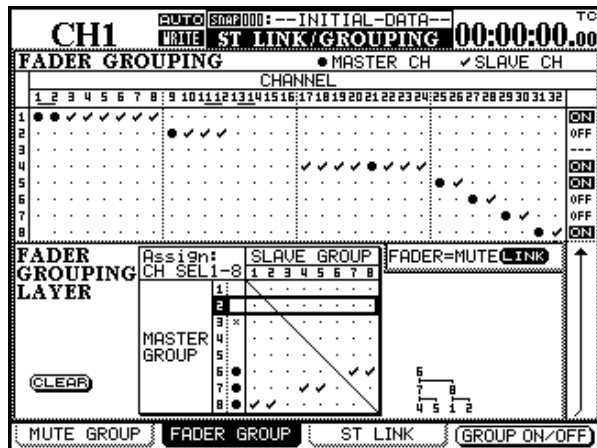

Groups are shown as horizontal rows in the matrix in the upper part of the screen. The 32 channels are shown as columns.

If a row (group) has no check marks or large “bullet” dots in it, no channels have been assigned to that group.

### NOTE

*It may not always be possible to see the flashing **SEL** key indicating a group master when you select a group on screen, as the master channel may be in an inactive fader layer.*

Press the unlit **SEL** key of any channel to assign the channel to the group.

If the channel is the first one to be assigned to the group, the symbol changes to a large bullet point, showing that it is the master channel of the group and the **SEL** indicator flashes.

If the channel is assigned to a group and it is not the first channel in the group, it is shown with a check mark to show that it is a slave channel, and the **SEL** indicator lights.

If a channel has already been assigned to a group as a slave and that group is currently selected, pressing the **SEL** key unassigns it from the group.

If a channel has already been assigned to a group as a master and another group is currently selected, press-

ing the **SEL** key to turn the channel into a slave channel brings up a warning message (Re-assign fader grouping?), and pressing **ENTER** reassigns the group. Any of the cursor keys may be used as “no” or “escape” keys here.

If a channel has already been assigned to a group as a master, pressing the **SEL** key clears the whole group. A popup message appears (Clear this fader grouping?), and pressing **ENTER** clears the group. Any of the cursor keys may be used as “no” or “escape” keys here.

## Fader groups to mute groups

At the right of the display, about halfway down the screen, there is an on-screen LINK button.

When this button is off, it is labeled FADER>MUTE.

Moving the cursor to this button and pressing **ENTER** brings up a popup asking whether a link should be made: Grouping link(Fader -> Mute) (**ENTER** for yes, cursor keys for no).

This transfers the fader groupings to the mute groupings (that is, the mute group settings become identical to the fader group settings). This is a “live link”—when changes are made to the fader groups, they are echoed in the mute groups and the other way round.

The button is now labeled FADER=MUTE and is shown in inverse, showing that the link is active.

Pressing the **LINK** button in either the fader or the mute group screens deactivates the link.

## Turning groups on and off

When a fader group is highlighted on screen (the cursor box surrounds it), either use the fourth soft key or

the **ENTER** key to turn the group functionality on or off. This does not clear the group settings.

## Grouping layers

It is often useful to make groups of groups in order to simplify mixing. This applies to both fader groups and to mute groups.

For example, when using mute groups, you might find it useful to group the vocal microphones of a session into one mute group, the drum microphones into another, and other percussion microphones into yet another.

In order to cut out any microphone spillage, these three microphone groups could be layered into a “supergroup” which controls all the microphone inputs.

It is also possible to layer the layers,

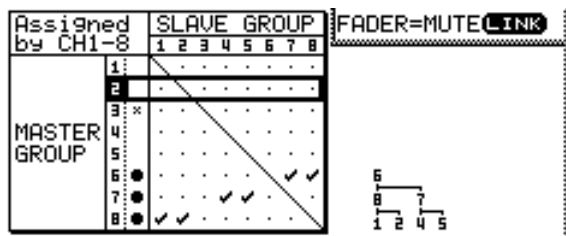

The right part of this detail showing a three-level layering setup is a tree diagram, showing that group 6 is the “supermaster” group. In other words, pressing the master **SEL** key of this group controls the status of

groups 7 and 8 (for mute groups) or moving the master fader of the group.

These “submaster” groups in turn control groups 1 and 2 (controlled by group 8) and 4 and 5 (controlled by group 7).

To use these grouping layers:

- 1 Use the **▲** and **▼** cursor keys or dial to navigate the cursor to the master groups shown as horizontal rows in the matrix at the lower part of the screen.

Empty groups (with no master or slave) are shown with an x by the group number)

- 2 Use the **SEL** keys of modules 1 through 8 as group selectors to assign slave groups.

### NOTE

Note that here the **SEL** keys do not refer to channels—they refer to the groups that have been set up in the top part of the screen. They can be used in this way in the two channel layers (1-16 and 17-32) but not in the **MASTER** layer.

Pressing the **SEL** key corresponding to any group **except** the highlighted master group adds (check mark) or removes (dot) the group to or from the layer controlled by the master group. The master group has

## 9 – Grouping—Grouping layers

a bullet mark added by its number when a subgroup is added (groups 6, 7 and 8 in the example screen).

The tree diagram is updated.

Pressing the **SEL** key corresponding to the master group brings up a popup message asking if the current group should be cleared (**ENTER** for yes, cursor keys for no).

Attempting to make a “circular group layer”, for example making group 5 into a submaster of group 2, and then attempting to make group 2 a submaster of

group 5, brings up an appropriate error message (Cannot assign fader grouping layer).

Moving the cursor to the **CLEAR** button allows all grouping layers to be cleared together. A popup message appears (Clear all mute grouping layers? (or fader in the case of fader grouping layers)). Pressing **ENTER** clears all group layers, but does not clear the groups themselves). Any of the cursor keys may be used as “no” or “escape” keys here.



The DM-24 contains a sophisticated monitoring system which allows different mixes to be set up in the control room and the studio, as well as an integral talkback microphone, lineup oscillator, etc.

## Control room monitoring

The control room (CR) monitoring section, which also includes two stereo headphone jacks, is located to the right of the stereo meters.

### Control room outputs

As might be expected, the control-room output signals are always output from the balanced 1/4" analog **CR (BAL)** connectors (+4dBu) ⑥.

However, if the digital outputs are not being used for any other purpose, the I/O OUTPUT screen may be used to assign the control room outputs to either the **DIGITAL 1** or **DIGITAL 2** sets of outputs.

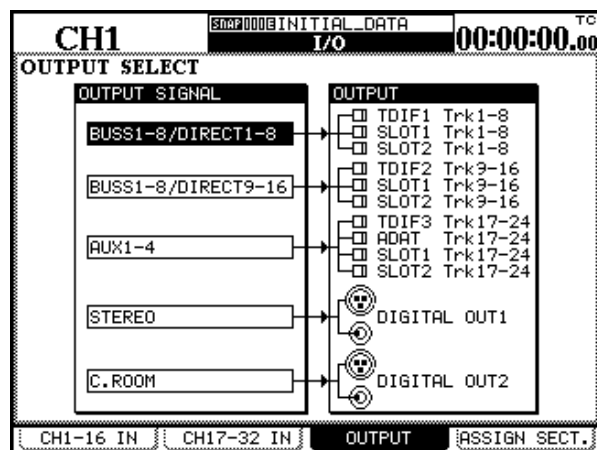

From the I/O screen, use the third soft key to bring up the output selection screen.

Move the cursor to either of the selection boxes opposite the DIGITAL OUT1 or DIGITAL OUT2 selector.

Turn the dial until C.ROOM is shown, and press **ENTER**.

The control room signal will now be output from the selected digital outputs.

#### NOTE

*The signal is sent from both the XLR-type jack and the RCA jack simultaneously. The output format (AES/EBU or SPDIF) is set using the DIGITAL display FORMAT sub-screen.*

The level of the signal sent from the analog outputs is adjusted by the **CR** control.

The level of the signal sent from the headphone jacks (both headphone jacks together) is adjusted using the **PHONES** control.

### Control room signal selection

There are four signal selection keys for the control room signal.

These are: **STEREO**, **SEL 1 (AUX 1-2)**, **SEL 2 (D IN 1)**, **SEL 3 (2 TR IN)**.

The first of these, **STEREO**, is hard-wired. That is, when this option is selected, the control room outputs as selected above will always output the stereo buss signal.

The other three keys are “soft”, and may be patched internally to output signals other than those given as the defaults (in parentheses on the panel).

The default settings may be useful when used in the following way, however:

When recording, aux sends 1 and 2 may be used as the studio cue mix, leaving aux sends 3 through 6 for effect use, etc. By using the **SEL 1** key set to the default **AUX 1-2** setting, it is therefore possible for the control room monitor to echo the signal sent to the studio.

When mixing, the mastering devices (connected to the stereo buss) may be digital or analog. The **SEL 2** key is by default set to the first digital input (whether this is the XLR-type connector or the RCA jack is determined in the channel IN screens of the I/O setup) and can therefore be used for monitoring the replay from the digital 2-track mastering device.

The **SEL 3** key is by default assigned to the analog 2-track inputs ⑨. These are typically used to monitor

## 10 – Monitoring—Studio monitoring

the playback from an analog mastering recorder connected to the DM-24.

The setting of these keys may be changed using the MONITOR screen.

With the **SHIFT** indicator lit, press the **METER/FADER [MONITOR]** key to bring up this screen:

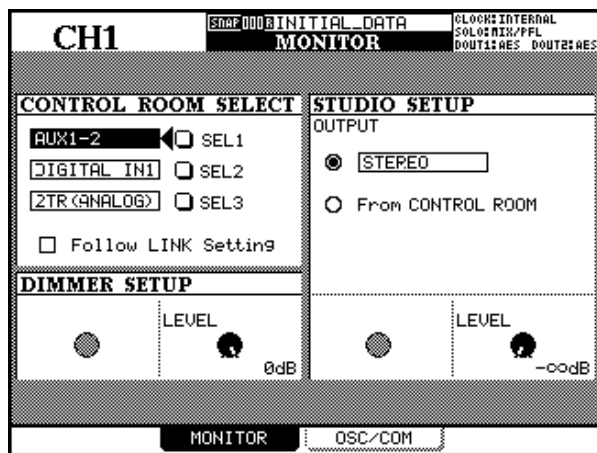

Use the cursor keys to move the cursor to the three selection key icons (SEL 1, SEL 2 and SEL 3).

Turn the dial to select from the available options: AUX 1, AUX 2, AUX 3, AUX 4, AUX 5, AUX 6, AUX1-2, AUX3-4, AUX5-6, BUSS 1, BUSS 2, BUSS 3, BUSS 4, BUSS 5, BUSS 6, BUSS 7, BUSS 8, BUSS 1-2, BUSS 3-4, BUSS 5-6, BUSS 7-8, DIGITAL IN 1, DIGITAL IN 2, 2-TR (ANALOG).

Press **ENTER** to confirm the choice.

### NOTE

*It is possible to assign the same option to more than one of the monitor selection keys.*

The Follow LINK Setting also affects what is output from the control room outputs. If a mono source which has been stereo linked (that is, an individual aux or buss) is selected, and the checkbox here is checked, the source will be stereo linked to its “partner” in the monitoring.

In this case, the odd-numbered aux or buss will be output from the left channel, and the even-numbered aux or buss from the right channel.

### 2-track input

Because of the analog nature of the **2TR IN** inputs, the following should be noted when monitoring from this source:

- Dimming when monitoring this signal is fixed at a level of  $-30\text{dB}$  relative to normal and cannot be changed.
- If the control room output is set to one of the **DIGITAL OUTPUTS (1 or 2)** as explained earlier

(“Control room outputs” on page 73), it is not possible to monitor the 2-track source

- In addition, even though the studio output is an analog output, if the control room monitoring system is set up to use a digital output, it is not possible to monitor the 2-track inputs through the studio system when echoing the control room outputs to the studio (see below, “Studio monitoring” on page 74).

### Studio monitoring

The studio monitoring can be selected to follow the control room monitoring selection or to be independent of the control room monitoring using the same screen as the control room setup (above).

To make the studio outputs follow the control room sources:

On the main monitoring page (soft key 2) move the cursor to the From CONTROL ROOM “radio button” and press **ENTER**. When this is selected, whatever is selected for the control room output will also be output from the studio monitoring outputs.

To set a different source for the studio, move the cursor to the output select “radio button” and press **ENTER** to select the monitoring source displayed to the right of the radio button.

After this, move the cursor to the right and use the dial to select from the list: Stereo, Buss 1-2, Buss 3-4, Buss 5-6, Buss 7-8, Aux 1-2, Aux 3-4, Aux 5-6, Digital In 1, Digital In 2, 2TR(Analog). Press **ENTER** to confirm the selection.

A pair of aux sends makes a good choice for the studio source, as these can be individually adjusted pre-fader, and a completely separate studio mix can be built up in this way.

## Studio monitoring volume

The volume of the studio monitoring outputs is set on the same screen as the output selection, using POD 4.

The level is adjustable from  $-\infty$ dB (silence), to +10dB.

## Soloing

The solo facilities have been described briefly in the module section (“SOLO” on page 22), but are repeated here for convenience.

Note that soloing is provided only for the 32 input channels. It is not possible to solo aux sends or buses (use the control room selection “Control room signal selection” on page 73 for this).

The DM-24 provides two modes of soloing, as explained here. Soloing occurs when both the **SOLO** key (above the stereo fader) and the **MUTE** key of at least one channel are active. What happens when this

happens is dependent on the settings made in the SOLO screen (from the OPTION display).

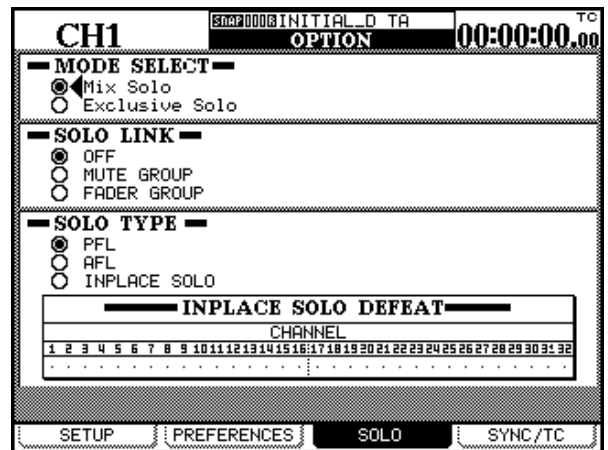

### MODE SELECT

Either Mix Solo or Exclusive Solo can be selected here. The Mix Solo mode allows a number of channels (that is, all whose **MUTE** keys are flashing or lit in solo mode) to have their outputs added together to the

solo mix. The Exclusive Solo mode only allows one channel (the one whose **MUTE** key was pressed last) to be soloed at one time.

### SOLO LINK

This option allows the fader and mute groups (see “Grouping” on page 69) to be used with the solo function.

If one of the group options (MUTE GROUP or FADER GROUP) is enabled, selecting a group master channel solos or unsolos the whole of the group. This is regardless of the Mix Solo/Exclusive Solo setting described above.

If a group slave channel is selected, the solo status of only that slave channel is affected. The effect on other previously-soloed channels (whether or not they are part of the group) depends on the Mix Solo/Exclusive Solo setting described above.

See also “Turning soloing on and off” on page 76.

### SOLO TYPE

There are three options that may be selected here: PFL (pre-fader listen), AFL (after- or post-fader listen). Again, these are explained in more detail in the solo section, but briefly:

**PFL** provides a way of listening to the signal before it is sent through the panpot and fader. The stereo

outputs are unaffected (soloing is only done through the monitor outputs—**CR** and **STUDIO**).

**AFL** outputs the post-fader (pre-pan) signal from the selected channels through the monitoring system.

**INPLACE SOLO** monitors the soloed signal(s) via the stereo outputs while all the other signals are cut from the stereo outputs.

## 10 – Monitoring—Dimming and talkback

Depending on the solo type selected, the **SOLO** key (above the **STEREO** fader) and the **MUTE** key of any soloed channel(s) will flash or light:

PFL	fast flashing
AFL	slow flashing
Inplace	lit

### Inplace solo defeat

The solo defeat option prevents channels selected in this way from being muted when other channels are soloed. It can be used with a pair of effect returns, for instance, so that these effect returns will always be added in the inplace mix, together with those other channels selected for inplace soloing.

Inplace soloing will output the soloed channel(s) from the stereo outputs, and cut all other channels.

Use the cursor keys (or the channel **SEL** key) to highlight a channel (“box” cursor), and the **ENTER** key to change the status of the INPLACE SOLO DEFEAT.

### SOLO level

The level of the PFL and AFL signals is determined by the **SOLO** control above the monitor selection keys. The indicator by this control lights or flashes

(depending on the selected solo mode) when any soloing is taking place.

### Turning soloing on and off

The **SOLO** key with integral red indicator above the **STEREO** fader is used to turn the solo mode (as selected in the option screen) on and off.

When soloing is active, this indicator lights or flashes (as does the indicator above the **SOLO** level control). All previously-lit **MUTE** indicators go out.

The **MUTE** keys are used to control which channels are soloed. Pressing the **MUTE** key of a channel will un-mute it, therefore soloing it. The **MUTE** indicator of a soloed channel lights or flashes.

If Mix Solo is selected as the solo mode (see “MODE SELECT” on page 75, pressing another **MUTE** key will add that channel to the solo mix. If solo linking is switched on, and the channel is a group master, all

channels which belong to that group will be soloed. More than one group may be soloed at a time in Mix Solo mode.

If Exclusive Solo is selected as the solo mode, the channel whose **MUTE** key was pressed last will be soloed. If solo linking is turned on, and the channel is a group master, all channels which belong to that group are soloed. If another channel’s **MUTE** key is pressed (whether or not the channel is part of the group or not), only that channel will be soloed. Only one group at a time may be soloed in Exclusive Solo mode.

The type of soloing (pre-fader, etc.) is determined by the settings described in “SOLO TYPE” on page 75.

### Dimming and talkback

On the same screen as the control room selection, it is possible to change the amount by which the control room outputs are “dimmed” (attenuated) when the dim is active or the studio-routed talkback is active.

Use POD 2 to set the level to the level that the dimmed output will be, relative to the normal control room level. This can be set from –40dB to 0dB in 1 dB steps.

When dimming the studio output, the **DIMMER** key acts as a “smart” key. That is, if pressed and released quickly, the dimming status latches on or off. Pressing and releasing the key quickly again changes the status back again.

If the key is pressed and held for more than half a scone, the switch becomes non-latching, that is, the dimming status is on as long as the key is held down.

Whenever the dimming is active, the indicator is lit.

The level of the talkback microphone (which is located below the **PHONES** control) can be adjusted using the **T/B** control.

The talkback signal can be routed to the studio outputs (use the **STUDIO** key) or to a “slate” (use the **SLATE** key), that is, to a selected group of aux and buss outputs, as explained below.

Both the **STUDIO** and **SLATE** keys are smart keys working in the same way as the **DIMMER** key. If

pressed and released quickly, they are latching, but if pressed and held, they are non-latching. Indicators show the active status of these keys.

## Slate settings

The DM-24 allows you to define the “slate”—the destination of the talkback microphone.

From the MONITOR screen, press the third soft key (OSC/COM) to bring up the oscillator and slate setting screens.

Use the **SLATE** panel in this screen to choose which aux sends, output busses and stereo channels will be included in the slate.

Use the cursor keys to move along the row, and the **ENTER** key to include and uninclude the busses,

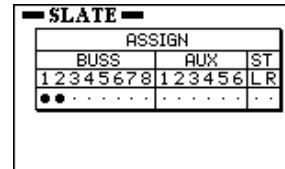

## Lineup oscillator

The DM-24 includes a lineup oscillator, which can be assigned in the same way as the slate output.

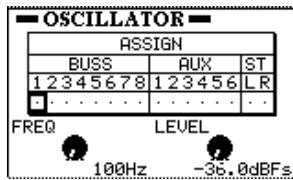

In addition to being able to choose the outputs to which the oscillator is sent, POD 1 allows the oscillator frequency to be selected (100Hz, 440Hz, 1kHz or 10kHz).

The level of the oscillator is also variable (POD 2) from -36.0dBFS to 0.0dBFS in 0.5 dB steps.

Use soft key 1 to turn the oscillator on (button is in inverse video) and off.

## Meters and faders

As well as the stereo meters, the DM-24 provides on-screen metering for all modules in the console.

With the **SHIFT** indicator unlit, press the **METER/FADER** key.

The following screen shows the metering for the input channels:

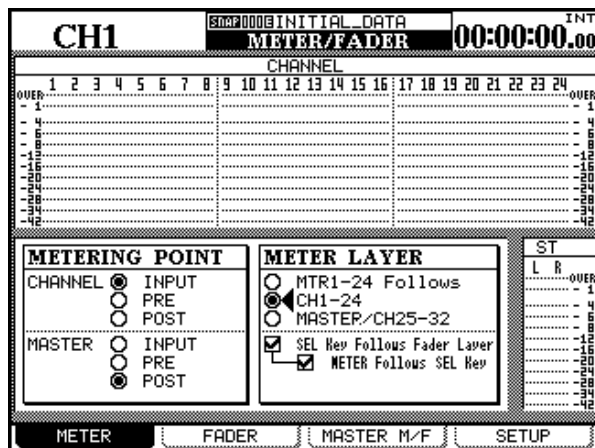

The METERING POINT for channels 1 through 32 (CHANNEL) can be set as INPUT (before the digital trim and after the input selection), PRE (pre-fader and before any assignable send/return insert), or POST (post-fader, and post any assignable send/return insert).

The MASTER (aux sends, busses, stereo) metering point can also be set: INPUT (buss level, before any compressor insertion), PRE (pre-fader and post any compressor insertion), and POST (post fader).

Since only 24 channels can be shown on screen at once, there is a choice of what will be metered on screen at any one time: either the 24 track returns, the

# 10 – Monitoring—Meters and faders

24 channels or a screen with channels 25 through 32, aux sends 1 through 6 and busses 1 through 8:

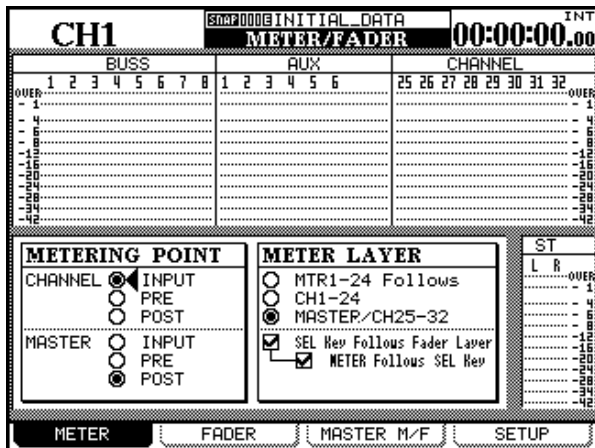

The SEL Key Follows Fader Layer allows the setup of the automatic linking of the selected channel to the selected meter layer.

When this option is selected, if a channel is selected, the fader layer is changed, and then the fader layer is changed back again, the originally-selected channel is automatically selected.

For example, if this option is active, and SEL 2 key is lit with fader layer 1-16 active, fader layer 17-32 is

then selected, SEL key 3 (channel 19) is selected, and then fader layer 1-16 is then re-selected, SEL key 2 will be active.

If the option is not active, any SEL key which is lit remains lit when the fader layer is changed. For example, if this option is not selected, and SEL key 2 is lit with fader layer 1-16 active, and fader layer 17-24 is then selected, SEL key 2 will still be lit (that is, channel 18).

When the Meter Follows SEL key option is checked, the meter layer automatically changes when an appropriate SEL key is pressed. The modes are as follows:

Fader layer	SEL keys	Meter layer
CH 1-16	CH 1-16	CH 1-24
CH 17-32	CH 17-24 CH 25-32	CH 1-24 MASTER/CH 25-32
MASTER	Buss 1-8/Aux1-6/Stereo	MASTER/CH 25-32

### NOTE

If the FADER->METER Follow option is checked, and the SEL Key Follows Fader Layer is not checked, the meter follow option will not be enabled.

These settings can also be made in the OPTION PREFERENCES sub-screen ("PREFERENCES" on page 21).

## Master meters

As well as the option described immediately above, pressing soft key 3 in the METER/FADER display provides a view of the master meters and faders as shown here:

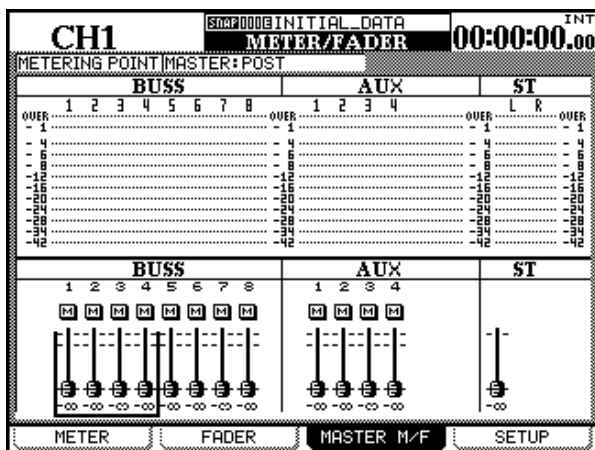

The METERING POINT can be set (ENTER key, dial and ENTER key) in the same ways as described earlier (here the options are described as PRE (pre-fader), POST (post-fader) and INPUT (input)). Changes made here are reflected in the METER screen and vice versa.

Use the SEL or cursor keys to move the box cursor around the screen in groups of 4 modules, and the PODs to set the fader values.

## Channel faders

It is sometimes useful (for instance, in automation) to have a view of the fader levels while another fader layer is selected.

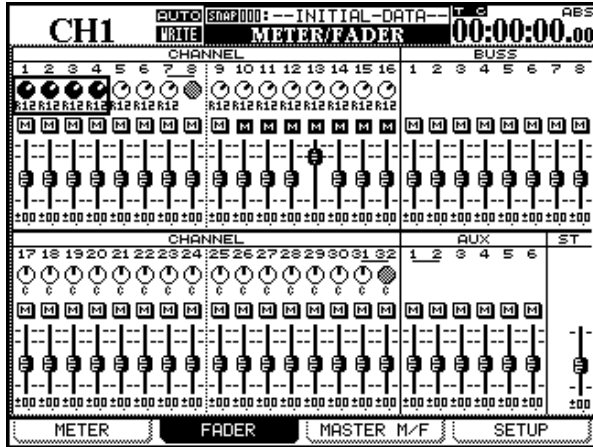

The FADER screen shown here (accessed with soft key 2), as well as the MASTER M/F screen immediately above, provides such a view.

In addition, the pan settings and fader levels of the channels (fader level only in the case of the aux sends and busses) can be changed.

The mute settings for all modules can be viewed.

Use the cursor and PODs to change the pan settings or the fader levels on screen. Channels are selected using the cursor and **SEL** keys in blocks of 4, corresponding to the 4 PODs.

### NOTE

*If the DM-24 is in a surround mode, these pan controls affect the position of the channel in the front L-R outputs.*

If the fader layer being edited is selected, the appropriate fader(s) will move as the on-screen faders are moved.

Normalised faders change appearance, as in “Fader section” on page 51.

The **SEL** keys can also be used to navigate around the groups.

## Meter and fader setup

Use this screen to set meter characteristics, and to transfer a specific value to a fader or group of faders.

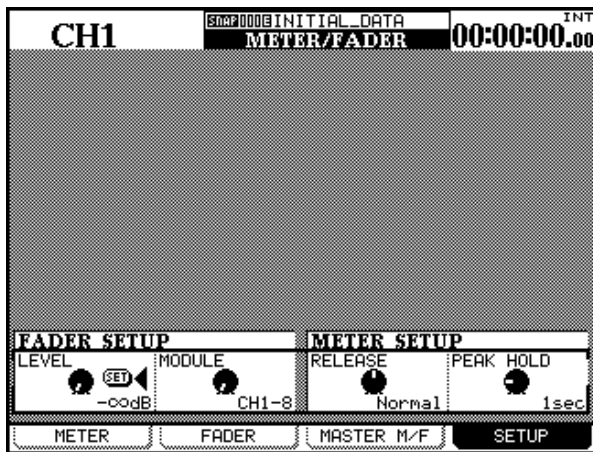

**Fader level** Use POD 1 to change the fader level (LEVEL) between  $-\infty$  and  $-36\text{dB}$  in 128 steps.

Use POD 2 to select the scope of the setting: groups of eight channels (CH1–8, CH9–16, CH17–24, CH25–

32), the eight busses (BUSS1–8), the six aux sends (AUX1–6), the stereo master (STEREO), the individual channels (CHx), the individual busses (BUSSx), the individual aux sends (AUXx) or all channels (ALL CH).

Press **ENTER** to copy the level. A popup message appears. Press **ENTER** again to confirm the copy, or a cursor key to cancel the operation.

**Meter ballistics (METER SETUP)** The RELEASE (fall time) of the meters can be set to either Slow, Normal or Fast using POD 3.

Use POD 4 to set the peak hold time (PEAK HOLD) to Off, 1, 2, 4, 8 or  $\infty$  (seconds). In the case of an infinite hold ( $\infty$ ) the peak levels can be reset by selecting another value or changing the meter layer.

These settings refer to both the on-screen meters and to the optional meter bridge meters. Note that when the meter layer is changed using the optional meter bridge, the STEREO master meter peak hold is not cleared.

# 11 – Machine Control/Location

The DM-24 is capable of acting as a remote control unit for a wide variety of external devices.

The exact functionality of the machine control depends, of course, on the device to be controlled.

The device control is carried out through the DTRS control port, the MIDI connections (for MMC), or the serial port (RS-422).

Different devices can be selected for simultaneous control by the DM-24, with different devices being

controlled in different ways. For instance, it is possible to select one device to have its transport functions controlled by the DM-24, while the DM-24 controls the track arming functions of another device.

### NOTE

*In this section, the term “controller” is used to refer to a part of the DM-24 software controlling an external device, rather than a hardware feature of the device or the DM-24.*

## Selecting devices for control

The **EXT CTRL – MIDI/MC** key is used to set up the control of external devices.

- 1 With the **SHIFT** indicator lit, press the **EXT CTRL [MIDI/MC]** key.
- 2 Use the second soft key to bring up the machine control screen (MACHINE CTRL):

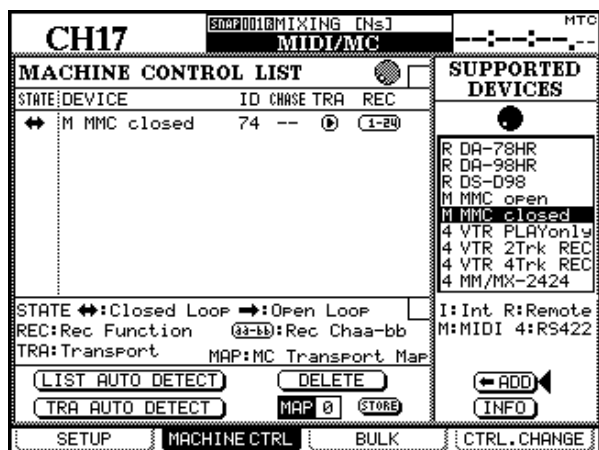

- 3 With the cursor pointing to either the **<-ADD** or **INFO** buttons, use the dial to scroll through the list of devices on the right of the screen that may be controlled by the DM-24 (SUPPORTED DEVICES).
- 4 When a device to be controlled by the DM-24 is selected in the list, move the cursor to the **<-ADD** button, and press **ENTER**. The device will be added to the list.

To obtain more information regarding a particular item in the list of devices which may be controlled by the DM-24, highlight the item, move the cursor to the **INFO** button, and press **ENTER**. A popup screen provides information regarding the list item.

At the bottom of the list is a key to the method used for controlling each item in the list:

Display	Meaning
I	Internal devices
R	REMOTE (DTRS)
M	MIDI Machine Control
4	P2 (RS-422)

The current list of devices (at the time of writing) is:

Device	Screen display	Control type
MIDI Timecode generator	MTC Generate	I
Cascade mastering	CASCADE MSTR	I
DA-88 DTRS recorder	DA-88	R
DA-38 DTRS recorder	DA-38	R
DA-98 DTRS recorder	DA-98	R
DA-78HR DTRS recorder	DA-78HR	R
DA-98HR DTRS recorder	DA-98HR	R
MMC open-loop control	MMC OPEN	M
MMC closed-loop control	MMC CLOSE	M
VTR (playback only)	VTR PLAYonly	4
2-track VTR with record support	VTR 2Trk REC	4
4-track VTR with record support	VTR 4Trk REC	4
MMR-8 or MMP-16 TASCAM HD recorder	MMR8/MMR16	4
DAT recorder with timecode track	TC DAT	4

Other devices may be added to the list of supported devices in the future. If the list does not contain the name of a device that you wish to control, please contact your TASCAM dealer regarding the availability of a software upgrade which contains the control capability for your device.

Up to 16 devices may be added to the Machine Control List. If more devices are connected and added to the list than can be shown on screen, arrow marks appear at the top and bottom of the list.



## 11 – Machine Control/Location—Selecting devices for control

When an entry in the Machine Control List is highlighted (that is, the cursor is on the left of the screen),

the dial is used to scroll through the list, including those items which may not be visible on the screen.

---

### Deleting devices from the list

If a device is added in error to the Machine Control List (or is no longer required), highlight the device,

move the cursor to the on-screen DELETE button, and press **ENTER**. The last item in the list will be deleted.

This process can be repeated to clear the list.

---

### Auto-detection of devices

In addition to the manual addition of controlled devices, there are two auto-detect buttons. One is used for detecting all devices attached to the DM-24 (LIST AUTO DETECT) and the other is used for transport mapping (see “Machine Control mapping memories” on page 82 below).

Move the cursor to the on-screen LIST AUTO DETECT button and press **ENTER** to scan the control ports and report on the detected devices, adding the controllers to the Machine Control list (see “Machine Control mapping memories” on page 82).

#### NOTE

*Because not every device that may be controlled by the DM-24 is capable of reporting its presence accurately, some devices will not appear on the list, and must be added to the list manually.*

When attempting to identify a MIDI device, the DM-24 first sends out an MMC Read Signature command. It adds a generic “closed loop” device for every device ID that responds to this command.

It also sends out a MIDI Device Inquiry Message. If a remote device replies to this message, and an appropriate controller is available, this controller replaces the generic MMC closed-loop controller.

After power has been applied, it may take between one and two minutes for the remote devices to be recognized. Even if they have been added to the memorized Machine Control list previously, it may not be possible to control them immediately the system is powered up.

---

### Selecting the control type for the devices

The Machine Control list is composed of a number of columns. These are explained below:

**STATE** An icon shows the state of the controlled device. A one-way arrow represents an open-loop device (that is, commands are sent from the DM-24 to the device, but no information is transmitted back from the device to the DM-24 along the same channel—information is transmitted from the other device through a different channel, such as timecode or MIDI).

A double-ended arrow represents a closed loop, where information flows both ways between the remote device and the DM-24 along the same channel.

A cross indicates that the device is not being controlled by the DM-24.

Two dashes (--) show that the type of control is not relevant here (for instance, the internal MIDI timecode generator).

**DEVICE** The name of the name of the device being controlled, together with its control type. These list items cannot be changed or edited.

**ID** In the case of DTRS units, it refers to the unit ID, and cannot be edited. In the case of MMC units, it refers to the MMC ID (2 hexadecimal digits) of the unit. This list item cannot be changed or edited. Use the **JOG** dial to change the value and confirm with **ENTER**.

**CHASE** This applies to DTRS units, and allows the CHASE mode of the selected unit to be turned on or off. Any unit which can have its chase mode controlled by the DM-24 has this item represented by a square box. Units whose CHASE mode cannot be remotely controlled have this item represented by two dashes (--). Use the cursor keys to navigate to the list item, and the **ENTER** key to toggle between on (a check mark is shown in the box) and off (the box is empty).

## 11 – Machine Control/Location—Selecting devices for control

**TRA** This two parameter allows the transport controls of the DM-24 to control the transport of the selected device (TRA).

Only one device at a time can be selected for transport control, as shown by the circled **#** symbol. If a device has been selected for transport control, and it is required to control another device, the first device selected for external control must be de-selected from transport control before the “new” device is selected for this purpose.

If the device is not active when an attempt is made to assign the transport control here, a popup message appears and the assignment is not made.

One feature which is not visible from the transport controls is an “eject” function. DTRS units, as well as most VTRs, can have their media ejected by pressing and holding the **STOP** transport key, and pressing the **CLEAR** key of the auto-punch section (not the number keypad **CLR** key).

Some machines may unthread the tape if the **STOP** key is pressed while the transport is stopped.

### NOTE

*The exact way in which the transport controls work with the external device depends on the capabilities of the device. For instance, the notion of “record” is not very meaningful when applied to the internal timecode generator.*

*If you require further information on the control features of a specific device that are not detailed here, please contact your TASCAM dealer, who should be able to supply you with further information.*

**REC** This allows the selection of the **REC** keys on the DM-24 which arm the tracks on the remote external device.

Use the dial to choose between 1-8, 9-16, 17-24, 25-32 (8 tracks), 1-16, 17-32 (16 tracks), 1-24 and 9-32 (24 tracks).

Use the **ENTER** key to confirm the choice.

An appropriate pop-up error message is displayed if an attempt is made to assign two overlapping groups of **REC** controllers. Use the **ENTER** key to accept the new assignment, or the cursor keys to dismiss this message and return to the previous assignment.

### NOTE

*When the **MASTER** indicator is lit (the master layer is selected), the module **REC** keys have no effect.*

The **ALL SAFE** key above the **STEREO** fader can be used to turn off the track arming for all tracks for all assigned **REC** keys. While **ALL SAFE** is active, the **REC** keys are disabled, until **ALL SAFE** is turned off again. The recording status that was active before the **ALL SAFE** was turned on is restored when **ALL SAFE** is turned off again.

## Machine Control mapping memories

So that commonly-used machine control settings can be stored and recalled easily, the DM-24 provides 10 memories of machine control mappings (numbered from 0 through 9).

Each of these may contain a device which may be controlled by the transport control facilities of the DM-24.

Each of these memories includes: the CHASE setting, the SCR setting and the TRA setting.

An example of the practical use of this, take the example of three DTRS units connected to a VTR, chasing to timecode supplied by the VTR. Usually, the transport keys will control the VTR, and the **REC** keys will control the three DTRS units. The DTRS units will be locked and chasing the VTR. Sometimes, though, it will be necessary to control the DTRS units directly (through the first DTRS). Recording functions are still assigned to the DTRS units.

The mappings are automatically assigned when the TRA AUTO DETECT button is “pressed” after the units have been added to the list.

A pop-up window appears asking if the autodetect process should take place (as it will delete all previous mappings).

Press **ENTER** to continue with the autodetection, or any of the cursor keys to cancel the process.

When the scan is complete, a pop-up screen appears, showing the detected devices and their assignments to the control maps.

Any selected devices that may be controlled are detected and a new map is created for each such device.

A message is shown if there are more devices connected than can be added to the list (that is, more than 10).

If there are IDs associated with the devices, these are also shown.

## To use a machine control mapping

Of course, at least one machine control mapping must exist before this operation can be carried out.

- 1 Press and hold down the **SHIFT** key and the numeric **CLR** key.
- 2 Press the numeric key corresponding to the map you want to use (0 through 9).

The DM-24's transport control keys will now control the device selected in that map and the other mapping features will also be enabled.

The MAP field at the lower part of the screen shows the currently-loaded map.

## Viewing the transport mappings

To view the transport mappings (that is, the list of the devices that will be controlled in each mapping):

- 1 Press and hold down the **SHIFT** key and the numeric **CLR** key.
- 2 Press the **EDIT** key.

**A pop-up list appears on the screen. The device controlled in each map, together with its ID, is shown.**

- 3 Press the **ENTER** key to continue operations.

## Editing a mapping

When a mapping has been made, parameters other than the transport control may be edited (for instance, the use of the **REC** keys).

To make these changes a permanent part of the currently-loaded map:

- 1 Move the cursor to the number by the **MAP** field.
- 2 Use the dial to select the mapping memory into which the current mapping will be stored. Press **ENTER**.
- 3 Press **ENTER** (the on-screen **STORE** button).

## General parameters

When the **SHIFT** indicator is lit, press the **MIDI/MC** key. Use the first soft key to bring up this screen:

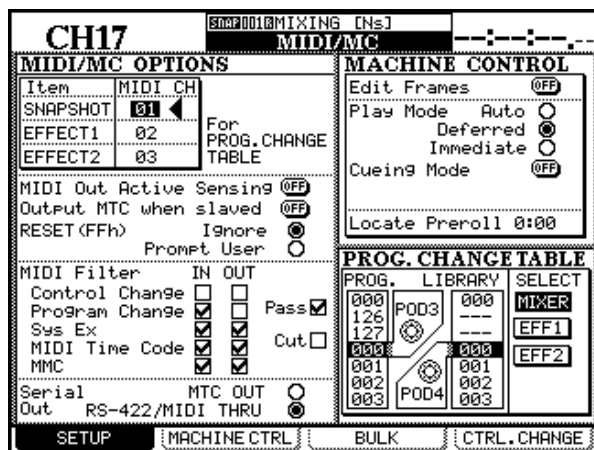

This allows the setting of such items as MIDI channels, the flow of MIDI data (including MIDI time-code) through the system, and various machine control parameters.

## Program Change channels

In order to allow independent remote changing of the mixer snapshots and the two internal effector settings using MIDI Program Change commands, these three libraries can be assigned to respond to Program Change commands received on different channels.

Move the cursor to the MIDI Ch box by either **SNAPSHOT**, **EFFECT 1** or **EFFECT 2** at the top left of the screen, use the dial to select the MIDI channel (from 1 through 16), and press **ENTER**.

## 11 – Machine Control/Location—General parameters

Each of these libraries must use a separate MIDI channel. A popup message is displayed if an attempt

is made to assign the same MIDI channel to more than one library.

---

### Program Change values

This setting allows a given Program Change number to be associated with a particular library entry. This means that there does not have to be an exact match between, say, a particular synthesizer patch number and number of the effect setting that you always use with that patch.

These settings are made at the bottom left of the screen. The three libraries mentioned above (snapshot and the two internal effects libraries) may have these settings made. The method is identical for each library.

- 1 **Move the cursor to the library table to be edited (MIXER for snapshots, EFF1 for effector 1, and EFF2 for effector 2).**
- 2 **Press ENTER.**
- 3 **Use POD 3 to select the MIDI Program change number.**
- 4 **Use POD 4 to select the library entry to be associated with the program change.**

Continue this process until the library Program Change table is set up as you want.

---

### General MIDI parameters

The following parameters may be set (consult a general reference work on MIDI if you are unsure of the operation of some of these MIDI functions):

**MIDI OUT Active Sensing** This turns the Active Sensing output from the DM-24 on and off.

**OUTPUT MTC when slaved** This controls whether the DM-24 will output MTC as an echo of

the input timecode when it is acting as a timecode slave.

**RESET (ffh)** This controls the action to be taken when a MIDI Reset message is received. The DM-24 can be either set to ignore all Reset requests, or when a Reset is received, to pop up a panel on the display informing the user asking if the Reset request is to be honored or ignored.

---

### MIDI filtering

The following types of MIDI messages can be set to be accepted or ignored by the DM-24 on input and/or output: Control Change messages, Program Change messages, System Exclusive (SysEx) messages, MTC (MIDI Time Code) and MIDI Machine Control (MMC) messages.

When a checkbox is checked, that particular MIDI message is accepted if the checkbox is in the IN col-

umn, and will be transmitted by the DM-24 if the checkbox is in the OUT column.

The PASS and CUT boxes are not selectable. There are there to remind you that a checked box means that the MIDI message is passed, and an unchecked box means that it is filtered (cut).

---

### Serial output

The DM-24 can be set to output its own timecode from the **MIDI OUT** port (MTC OUT).

Alternatively, it can output incoming timecode as MIDI timecode from the **MIDI THRU** and the **RS-422** serial port (RS-422).

---

### Edit Frames

When this is set on, location memories, etc. are edited to frame accuracy. When it is set to off, location settings are made to second accuracy.

## Play Mode

This function determines the way in which the **PLAY** key works in conjunction with the location facilities. There are three settings: Auto, Deferred and Immediate.

**AUTO** The **PLAY** indicator flashes as the unit is locating to a location point. When the location point is reached, playback starts automatically. However, if the **PLAY** key is pressed before the location point is reached, the unit stops locating and starts playing.

**DEFERRED** The unit stops after location is completed. However, if the **PLAY** key is pressed while the

unit is locating, the **PLAY** indicator flashes, and playback starts when the location point is reached.

### NOTE

*Because an open MMC connection cannot determine when the locate point has been reached, deferred play is not possible for a machine controlled in this way.*

**IMMEDIATE** The unit stops after location is completed. If the **PLAY** key is pressed while the unit is locating, the machine goes straight into play mode, without locating.

## Cueing Mode

“Cueing mode” here means that if the controlled device is in play mode, and either of the fast transport keys (forward or rewind) is pressed, the fast transport mode is not latched and the unit is in cue mode (that is, when the fast transport key is released, the unit goes back into play mode). To latch the unit in the fast transport mode, press the **STOP** key before entering fast transport mode.

A VTR controlled over the RS-422 connection which is put into fast wind with the cueing mode set on fast winds with the picture visible.

If cueing mode is not selected, when a fast transport key is pressed, irrespective of the current transport mode, the unit enters the fast transport mode, even when the fast transport key is released.

## Locate Preroll

Move the cursor to the numeric field, which shows the pre-roll time when a location point is reached (displayed in minutes and seconds). For example, if this field shows 0:10, if a location operation is carried out to a location memory of 00:20:32, the actual point located to is 00:20:22.

Note that this is used only in the case of Direct location (“Location to a location memory” on page 86), and not in the case of manual location operations (“Manual location” on page 87), which locates to the

value entered, irrespective of the pre-roll time set here.

Use the dial to set the pre-roll value and confirm the setting of this value with the **ENTER** key.

### NOTE

*A DA-98 DTRS unit controlled by the DM-24 always locates to a point about seven seconds before the location point as entered on the DM-24, irrespective of the setting made here.*

## Location memories

The DM-24 allows the storage and recall of up to ten location memories, allowing easy location of the controlled devices to predetermined cue points.

## Selecting the location point display

As explained in “LOCATE DISPLAY MODE” on page 20, the LOCATE DISPLAY MODE setting in the OPTION SETUP screen is used to determine whether the LED time counter shows the location memories as they are entered, edited and recalled, or whether they are shown as “popup” panels on the LCD display screen.

When this section mentions “the display” showing location memory values, this refers to the display that has been selected in this option.

### NOTE

*Depending on the settings for frame display (“Edit Frames” on page 84), the frames value may or may not*

## 11 – Machine Control/Location—Location memories

*be shown on the display when location memories are being edited, etc.*

### Storing a location memory “on the fly”

This procedure allows you to set a location memory, regardless of whether timecode is currently being received or not. If timecode is not currently being received, the value of the location memory is the last received value as shown on the time counter on the display.

The value on the time counter, regardless of source, is stored as the location memory. This may be timecode, MTC or an ABS time from a DTRS unit. However, only a controller which is specifically for DTRS use can locate a DTRS unit correctly, if there is an offset or other difference between timecode and the

ABS time. If an ABS time is captured, other controllers will assume that this was a timecode value, and will locate the unit to this timecode position.

- 1 Press the MEMO key. The indicator starts to flash.**
- 2 Press any of the numeric keys, corresponding to the ten location memories available.**
- 3 The MEMO indicator stops flashing and the currently-displayed timecode value is stored in the location memory corresponding to the numeric key which was pressed.**

### Manually entering and editing a location memory

This procedure can be used for editing existing location memories or for adding new ones.

- 1 Press the EDIT key. The indicator starts to flash.**
- 2 Press one of the number keys to select the location memory which will store the value. The EDIT indicator lights steadily.**
- 3 Enter the timecode value using the numeric keypad. The display shows the value, “filling up” from the right digit towards the left.**

**Or, if the EDIT key is pressed again after the location memory number has been pressed, the indicator starts to flash again, allowing the checking and editing of another location memory.**

- 4 Press the ENTER key when the timecode value for the location memory has been entered.**
- 5 Press EDIT again once to edit another location memory, or press EDIT twice to exit the location memory editing mode.**

**If the CLR key is pressed before the ENTER key, a location memory entry which has been made in error is cleared. Pressing ENTER stores the cleared memory.**

#### **NOTE**

*All blank location memories are assumed to be timecode memories. Editing one, and attempting to locate using ABS with a DTRS controller will almost certainly result in an unwanted result. It is suggested that an ABS time is captured first and then edited.*

It is possible to switch between the capture, edit and location procedures at any time.

### Location to a location memory

When the location memories have been entered, they are recalled in the following way:

- 1 Press the DIRECT key. The indicator lights.**
- 2 Press any one of the numeric keys, corresponding to the ten location memories.**
- 3 The controlled device locates to the memory stored in the location memory.**

**What happens next depends on the PLAY MODE setting (see “Play Mode” on page 85).**

#### **NOTE**

*If a pre-roll time has been set (“Locate Preroll” on page 85), the controlled device will locate to the location memory point, minus the value set as the preroll time.*

---

## Viewing a list of location memories

To view a popup list of all the location memories which have been stored:

**1 Press the SHIFT key so that the indicator is lit.**

**2 Press the EDIT key (now the LIST key as shown by the shifted legend).**

**The location memory source (timecode or MTC, or ABS) is shown, along with the value of each location memory.**

---

## Manual location

It is also possible to enter a location point manually, (from a cue list, for instance) and locate straight to it.

**1 Press the MANUAL key so that the indicator lights.**

**2 Use the number keys to enter a number in hh:mm:ss (and optionally frames) format.**

**3 When the ENTER key is pressed, the controlled device starts to locate to the location point just entered.**

This location point can be stored by pressing the **MEMO** key so that the indicator flashes, followed by pressing the **MANUAL** key again.

To locate to this point again after storing the location point, press the **MANUAL** key, followed by the **ENTER** key.

Note that the pre-roll time (“Locate Preroll” on page 85) does not apply here.

---

## Repeat play

Location memories 8 and 9 (accessed with the **8** and **9** keys) are used as the start and end points of a repeat loop that can be played by pressing the **REPEAT** key in the transport control section.

If point 8 follows point 9, or if the distance between the two points is very short, the behavior of the repeat playback depends on the device being controlled.

---

## Auto punch operations

For DTRS units, the three **AUTO PUNCH** keys: **RHSL**, **IN/OUT** and **CLEAR** are used in the same way as the corresponding keys on the DTRS unit.

Consult the documentation for the DTRS unit for details of how to perform punch operations.

When punch operations are taking place, the punch-in and punch-out points may be viewed and edited in location memories **4** and **5** respectively. When the **CLEAR** key is pressed to finish punch operations, the original location memories (if any) are restored.

---

## ALL INPUT and AUTO MON

The **ALL INPUT** and **AUTO MON** keys send the appropriate commands to all devices in the list that have the **REC** function enabled. When the function is active, the key’s indicator lights.

If the controller does not support the function, the indicator does not light.

If a number of controllers have had the **REC** function selected, some of which do accept this command,

and some which do not, the indicator will not light in the majority of cases.

DTRS devices can accept this command, as can MMC devices. Some devices controlled using the P2 protocol can accept these commands, but some cannot, depending on the manufacturer’s implementation of the protocol.

---

## External control

These following notes apply to the external control screens, etc. for some of the specific devices that may be controlled by the DM-24.

The list of devices which are assigned to the DM-24 for control is set up in the following way:

# 11 – Machine Control/Location—DTRS devices

Press the **EXT CTRL** key (**SHIFT** indicator should not be lit) to bring up the main external control screen:

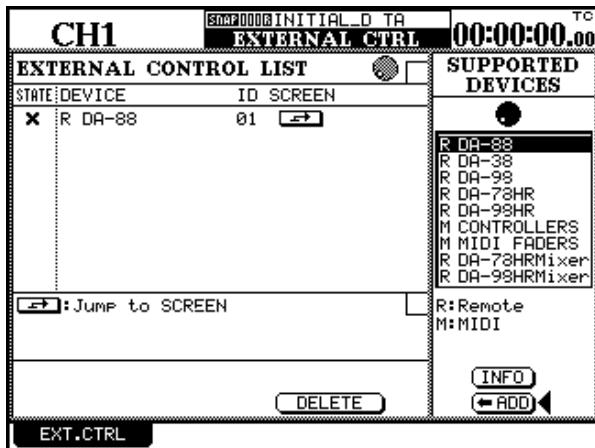

Initially, the list will be blank, but devices can be added as described here.

Note that this list is unconnected with the lists of machine and transport control devices described earlier in this section and refers to specific control capabilities of these devices, rather generic controls.

Move the cursor to the right column of the screen, and use the dial to scroll through the list of supported devices. When the desired device is highlighted, press the on-screen <ADD button to add it to the main list in the left part of the screen.

To obtain information on the selected device, press the INFO button for a pop-up message describing the connected device of the selected type.

As the device type is added to the external control list, the ID and the communication type (as described in “STATE” on page 81 and “ID” on page 81) are

also detected and displayed. The devices available are:

DEVICE	Screen name
DA-98HR DTRS recorder (“DA-98HR” on page 89)	DA-98HR
DA-78HR DTRS recorder (“DA-78HR” on page 91)	DA-78HR
DA-98 DTRS recorder (“DA-98” on page 91)	DA-98
DA-38 DTRS recorder (“DA-38” on page 92)	DA-38
DA-88 DTRS recorder (“DA-88” on page 92)	DA-88
Common MIDI Control Change Parameters for a single MIDI channel (“MIDI controllers” on page 93)	CONTROLLERS
Faders control a MIDI Control Change parameter on 16 channels (“MIDI faders” on page 93)	MIDI FADERS
DA-98HR internal submixer control (“DTRS mixer” on page 90)	DA-98HRMixer

Up to eight devices may be added in this way. If an attempt is made to add more, a popup panel (External Control List Full) appears. Press **ENTER** to dismiss this message.

In the case of MIDI devices (controllers and faders), the ID can be set to correspond to the MIDI channel in the case of controllers (see “MIDI controllers” on page 93), and the Control Change number in the case of faders (see “MIDI faders” on page 93).

To delete a device from the active list, move the cursor to the left part of the screen so that the dial scrolls through the active list.

Turn the dial to highlight the device to be deleted, move the cursor to the on-screen DELETE button, and press **ENTER**.

To jump to the specific control screen for the selected device, highlight the device so that the cursor is by the JUMP button, and press **ENTER**.

## Moving between screens

When an external screen is selected in this way, the bottom of the screen shows two buttons, accessed with soft keys 3 and 4.



These keys allow jumping between the different pages of the devices selected for external control in the main EXTERNAL CONTROL setup screen.

## DTRS devices

Depending on the functionality of the DTRS unit (DA-98HR, DA-78HR, DA-98, DA-88 or DA-38),

different options, such as track delay, dither setting, etc. are available, allowing these menu operations to



be carried out easily from the DM-24. Consult the documentation of your DTRS unit for full details of how these operations affect the unit.

It is essential the unit connected directly using the **DTRS REMOTE CONTROL** connection from the DM-24 has an ID of 1 (0 in the case of DA-88s). It is suggested that the other units in the chain are numbered in order following this (but this is not essential). Remember that all chains of DTRS units should be terminated.

If the DTRS units are to be word clock slaves of the DM-24, the dedicated word clock input of the DTRS unit connected directly to the DM-24 should be connected to the word clock sync output of the DM-24, and the clock source set to **WORD**. Subsequent units in the chain will receive their word clock information directly through the **REMOTE** connections, and do not require dedicated word clock connections.

Some specific information concerning the individual models in the range is provided here.

## DA-98HR

This screen (accessed using soft keys 3 and 4) allows the remote control of the following parameters.

### NOTE

When the DA-98HR is set to any sampling frequency other than the eight base-frequency track setting (including dual-frequency or quad-frequency recording modes), the number of tracks shown on screen whose parameters are shown will differ from those shown here. In addition, some features are only available in the eight track mode. Consult your DA-98HR documentation for full details of some of these features.

<b>CH1</b>		SNAP0008 INITIAL DATA		TC 00:00:00.00	
		EXTERNAL CTRL		PAGE 1/1	
FS:44.1K		TASCAM DA-98HR		ID: 01	
DIGITAL INPUT TDIF-1		TC/SYNC		Time Mode ABS	
INPUT PATCH		Src		TC REC (OFF)	
Ch		1 2 3 4 5 6 7 8		TC Generator (STOP)	
OUTPUT PATCH		Trk		Start Time 00:00:00.00	
Trk		1 2 3 4 5 6 7 8		Machine Offset +00:00:00.00	
INPUT MONITOR ON		PUNCH IN/OUT		Preroll 00m00s	
TRACK DELAY TIME		ALL UNIT		Postroll 00m00s	
TRK 1 TRK 2 TRK 3 TRK 4		DITHER OFF		VARI SPEED (OFF) -6.0%	
TRK 5 TRK 6 TRK 7 TRK 8		CLOCK		INT (selected)	
EXT. CTRL		← PAGE		PAGE →	

**DIGITAL INPUT** Use this to change between the TDIF and AES/EBU inputs.

**INPUT PATCH** The input patchbay can be viewed and set using this screen. Navigate around the matrix using the cursor keys.

**OUTPUT PATCH** View and set the output patchbay using this part of the screen.

**INPUT MONITOR** The individual track monitoring can be set and viewed with this part of the screen.

**TRACK DELAY** Can be set individually, or together. Move the cursor to the appropriate row and use the appropriate PODs to set the individual track or POD 3 to set all values together, and confirm with the on-screen SET button.

Change between samples and milliseconds as the unit of measurement, using POD 4.

**TIME MODE** Select between ABS and TC timing reference.

**TC REC** Arm and unarm the timecode track using this on-screen button.

**TC Generator** Start and stop the DA-98HR generator, as well as setting the start time. Individual hours, minutes, seconds and frames are set by navigating to the appropriate field.

**Machine Offset** Set this value here. Individual hours, minutes, seconds and frames are set by navigating to the appropriate field.

**PUNCH IN/OUT** Set the preroll and postroll values.

**DITHER** Set the dither type to off, rectangular or triangular.

**VARI SPEED** Can be set on or off, and the value changed to  $\pm 6.0\%$  relative to the nominal pitch.

**CLOCK** Choose between the different available clock sources for the DA-98HR: INT (internal), VIDEO, SLOT, WORD and the AES/EBU inputs. If the AES/EBU inputs are selected, the pair to be used as the clock source can then be chosen.

## DTRS mixer

In addition to the screen just described, there is an on-screen output mixer which controls the internal mixer of up to two DTRS units.

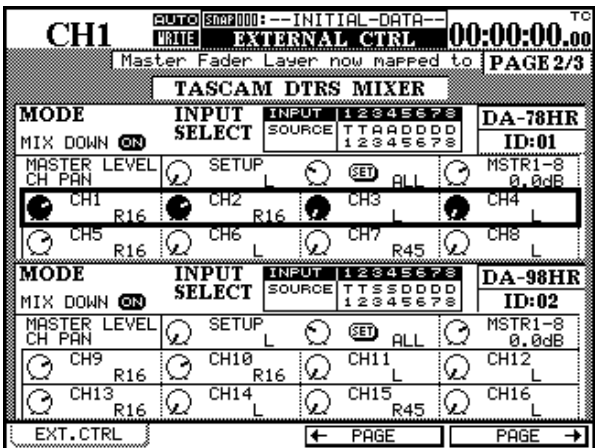
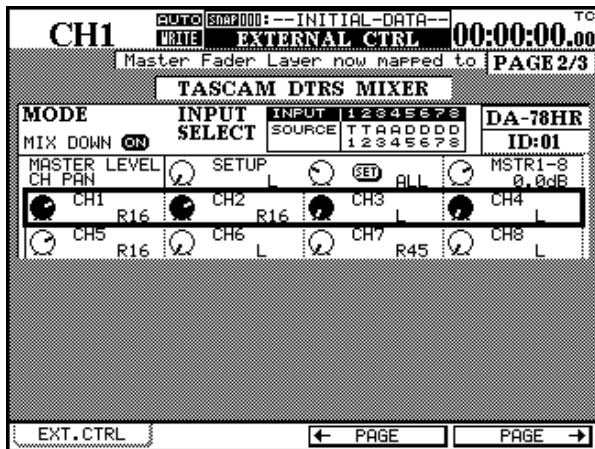

This is selected as a separate item in the list of devices to be controlled by the DM-24 (DA-98HR Mix). If this item is not added to the list of controllable devices, it will not be possible to make these mixer settings described here, even if the appropriate

DTRS units have been added to the list of controllable devices.

See the DTRS documentation for full details of how the mixdown mode functions with each model.

If more than one DTRS unit has been displayed in this way, the screen is split into two, with two “top rows”, etc.

The INPUT SELECT section at the top of each half-screen allows the assignment of sources to channels. Use the cursor keys, dial, and **ENTER** key to change these assignments. For DA-78HR units, these can be selected as Track (T), Digital (A) or Analog (A) and for DA-98HR units, they can be Track (T), Digital (D) or Slot (S).

The on-screen MIX DOWN button controls the mixdown mode of the DTRS unit.

In the first row of each half-screen, POD 1 allows the setting of a master PAN value, with a SET button to confirm the setting for a scope set by POD 2 (ALL, ODD, EVEN, 1-8 and 9-16).

Also in the first row, POD 3 is used to control the overall output master level for the first eight channels (the first unit), and POD 4 does the same for the second eight channels (the second unit).

The PODs in the remaining rows of the half-screen are used to control the pan positions of the outputs.

The master layer faders and **MUTE** keys are used to control the DTRS mixer when this screen is active (modules 1 through 8 control the first unit, and 9 through 16 control the second unit). While this is screen active, and the master layer is selected, the **MASTER** indicator flashes, as do the **MUTE** keys of the modules.

## DA-78HR

This is very similar to the DA-98HR settings displayed above, except that the eight tracks are always available (since the DA-78HR always has eight tracks available). The main other difference is the inability of the DA-78HR to provide individual input monitoring selection on a per-track basis, and so this feature is not present in the control screen.

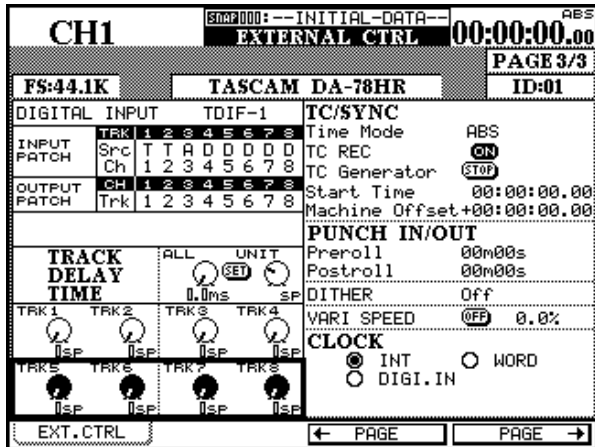

The digital input selection is between the TDIF1 inputs and the SPDIF input (2 channels only)

In addition, the clock sources which do not exist on the DA-78HR (video, AES/EBU and slot) are not available on this screen.

The internal mixers of up to two units can be controlled using another screen, in the same way as for the DA-98HR. In this case, the DTRS Mixer device must be added to the list of controllable devices. If this item is not added to the list of controllable devices, it will not be possible to make these mixer settings described here, even if the DA-78HR has been added to the list of controllable devices.

## DA-98

The DA-98 includes many of the features of the two units above, but with the following differences:

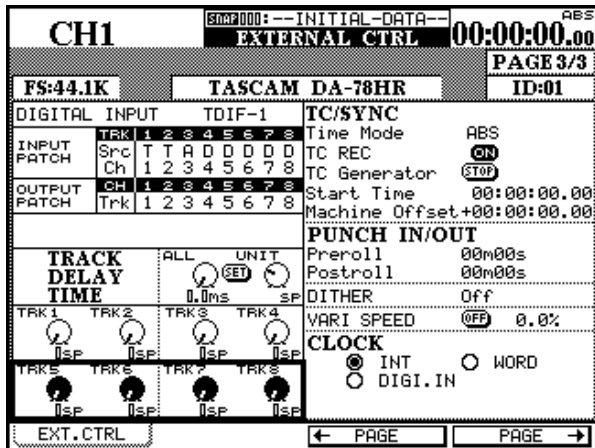

Digital input can only be switched on and off.

Track copying can be enabled or disabled, and the track copy routing can be set using the screen. Use the cursor to navigate to the input (IN) or the tape (TP) row, and use the dial to make the assignments between tape and inputs.

The input monitor can be switched on a track-by-track basis.

The three clock sources available are internal, word and video.

# 11 – Machine Control/Location—DTRS devices

## DA-38

The DA-38 does not include quite so many options as the DA-98.

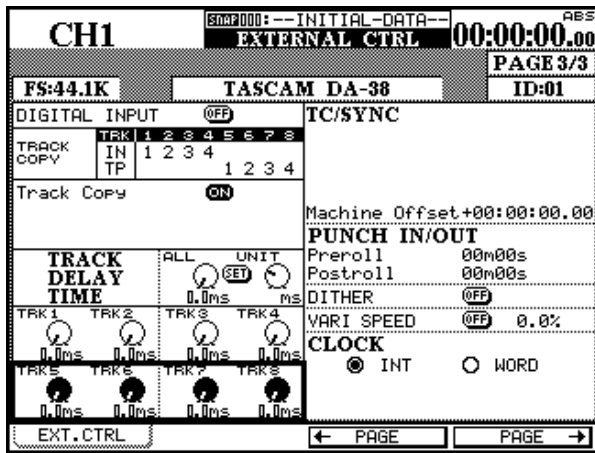

Input monitoring is not possible, but track copying is available in the same way as for the DA-98.

Since the DA-38 does not include a timecode generator, the range of options available in the TC/SYNC section is more limited, being restricted only to setting the machine offset value.

The clock sources are restricted to internal and word.

## DA-88

This provides the following facilities as shown on the screen here:

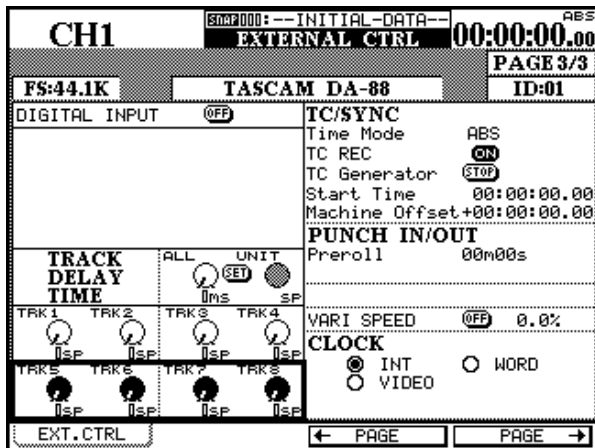

Similar to the DA-38, digital input can be switched on and off (that is, between analog and digital inputs).

The track delay time can be set individually, as well as a global setting. Use the PODs here to make the adjustment.

If an SY-88 card is fitted in the DA-88, the timecode settings can be made in the same way as for the DA-98 timecode.

Punch preroll time only can be set (postroll cannot be set).

Clock source options are restricted to internal, video and word.

## MIDI controllers

The PODs of the DM-24 can be used to send MIDI Control Change messages as described here.

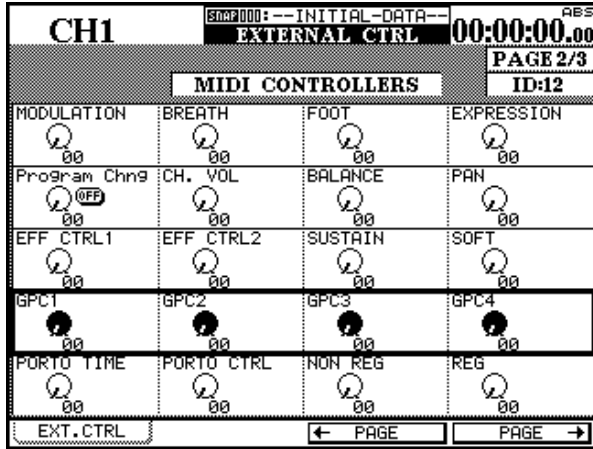

The most common controllers are listed here, and the cursor keys and PODs are used to set the values of these controllers on the selected channel.

The selected channel is shown at the top of the screen, and is the same as the ID selected on the setup page.

Control Functions available in this screen are:

No.	Control Function	No.	Control Function
01	Modulation	64	Sustain
02	Breath	67	Soft
04	Foot	16	Gpc1
11	Expression	17	Gpc2
		18	Gpc3
07	Ch.vol	19	Gpc4
08	Balance	5	Porto Time
10	Pan	84	Porto Ctrl
12	Eff Ctrl	99	Non Reg
13	Eff Ctrl	101	Reg

## MIDI faders

In the MIDI faders screen, the master layer of the DM-24 faders is used to control MIDI Control Change values, on the same controller, for all sixteen MIDI channels:

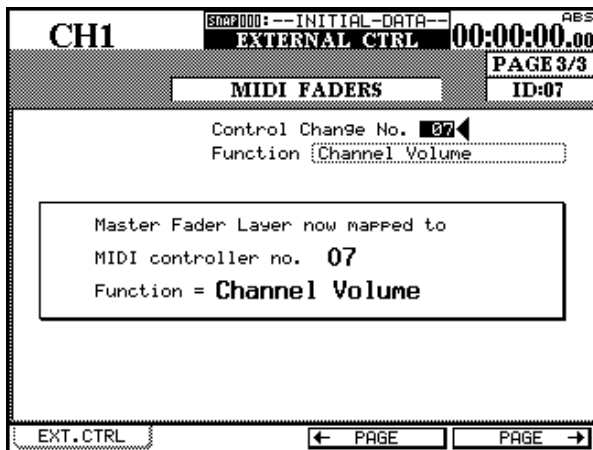

The MIDI Control Change number can be selected and set in this screen. As the example here shows, this may be used most often with MIDI volume (Control Change 7) in order to provide an easy way of independently controlling the volume of up to 16 MIDI devices connected to the DM-24.

## 11 – Machine Control/Location—MIDI faders

The MIDI faders may be used to control the following settings:

No.	Control Function	No.	Control Function
00	Bank Select	50	GP Controller 3 (LSB)
01	Modulation	51	GP Controller 4 (LSB)
02	Breath Control	52 - 63	Undefined
03	Undefined	64	Damper Pedal (sustain)
04	Foot Controller	65	Portamento On / Off
05	Portamento Time	66	Sostenuto
06	Data entry MSB	67	Soft Pedal
07	Channel Volume	68	Legato Footswitch
08	Balance	69	Hold 2
09	Undefined	70	Sound Variation
10	Pan	71	Harmonic Intensity
11	Expression	72	Release Time
12	Effect Control 1	73	Attack Time
13	Effect Control 2	74	Brightness
14 - 15	Undefined	75	Sound Controller 6
16	GP Controller 1	76	Sound Controller 7
17	GP Controller 2	77	Sound Controller 8
18	GP Controller 3	78	Sound Controller 9
19	GP Controller 4	79	Sound Controller 10
20 - 31	Undefined	80	GP Controller 5
32	Bank Select (LSB)	81	GP Controller 6
33	Modulation (LSB)	82	GP Controller 7
34	Breath Control (LSB)	83	GP Controller 8
35	Undefined	84	Portamento Control
36	Foot Controller (LSB)	85 - 90	Undefined
37	Portamento Time (LSB)	91	Effect 1 Depth
38	Data entry MSB (LSB)	92	Effect 2 Tremolo
39	Channel Volume (LSB)	93	Effect 3 Chorus
40	Balance (LSB)	94	Effect 4 Detune
41	Undefined	95	Effect 5 Phaser
42	Pan (LSB)	96	Data increment
43	Expression (LSB)	97	Data decrement
44	Effect Control 1	98	Non-Registered LSB
45	Effect Control 2	99	Non-Registered MSB
46 - 47	Undefined	100	Registered LSB
48	GP Controller 1 (LSB)	101	Registered MSB
49	GP Controller 2 (LSB)	102 - 119	Undefined

The DM-24 can be used for control of MIDI devices, as well as being controlled by them.

In the section on machine control, it is explained how the DM-24 can be used to control MIDI devices, using the PODs to transmit different common Control Change messages on a single channel (“MIDI controllers” on page 93) or using the faders to send the same Control Change message on up to 16 different MIDI channels (“MIDI faders” on page 93).

In the section on Machine Control, it is also explained how the DM-24 can be set up to use or ignore certain MIDI messages, as well as other MIDI setup parameters (“General MIDI parameters” on page 84 and “MIDI filtering” on page 84).

The DM-24 can also be controlled by means of MIDI messages, etc. as well as being able to save and load library settings, etc. to and from MIDI bulk storage devices, by using System Exclusive bulk dump messages.

## Bulk dumps

This provides a convenient way for you to store and recall the settings you make on the DM-24. Since most sequencer programs, etc. allow you to save such System Exclusive dumps on floppy disks or other portable media, you can easily carry the settings for a project (including all the automated mix moves) between different facilities equipped with DM-24s.

In addition, if you have two DM-24 units side-by-side, it is possible to use this facility to transfer settings from one unit to another.

In each case, the **MIDI OUT** of the DM-24 must be connected to the **MIDI IN** of the remote unit, and the **MIDI IN** of the DM-24 to the **MIDI OUT** of the remote unit.

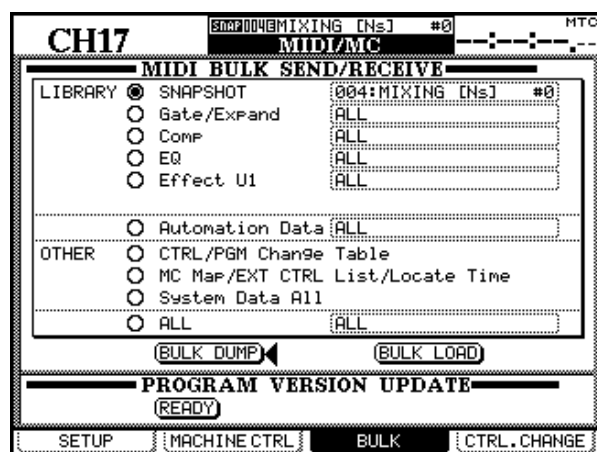

Enter the MIDI BULK SEND/RECEIVE screen by pressing **MIDI/MC** key with the **SHIFT** indicator lit.

Then use soft key 3 to bring up this screen.

It is possible to save the library memories for snapshots, dynamics processors (gates and expanders, and compressors), the EQ library entries and the two internal effector entries. These can be saved as ALL entries in that library, or individually).

Automation data can also be stored in this way (individual banks or ALL).

Other options are the Program Change table (“Program Change values” on page 84) and the Control Change tables (“Control Change messages to and from the DM-24” on page 96) stored together as CTRL/PGM Change Table.

The Machine Control Mappings, the external control list and the location time memories (“Location memories” on page 85) can also be selected for MIDI dump storage (MC Map/EXT CTRL LIST/Locate Time).

All system data can also be dumped in this way (System Data All).

Last on the list is the ALL option, where all the above options—the contents of all libraries as well as the other data described above (ALL), all the library entries of all the libraries, (LIBRARY) or all the library entries of all the libraries together with the automation data (Library+Automation) can be selected for dumping.

### Bulk transfer of data from the DM-24

Prepare the other MIDI device to receive System Exclusive bulk data.

Select the data to be transferred from the DM-24. When the appropriate set of data to be dumped to the MIDI device has been selected, move the cursor to the on-screen **BULK DUMP** button, and press **ENTER**.

A popup appears, giving the progress as a percentage as the data is transferred to the remote bulk device.

The dump process can be halted by pressing any of the cursor keys.

## 12 – MIDI—Updating the system software

At the end of the dump, the popup display shows Done! and then disappears from the screen.

---

### Bulk transfer of data to the DM-24

When the appropriate set of data to be dumped to the MIDI device has been selected, move the cursor to the on-screen BULK LOAD button, and press **ENTER**.

A popup message appears, saying that the DM-24 is now ready to receive the selected data. At this point, a cursor key can be pressed to cancel the operation.

At this point, it is a good idea to check that important data which is needed and stored on the DM-24 will not be overwritten by the incoming data.

The bulk dump from the remote device should then be started. The receiving DM-24 shows that the start command has been received and when the data transfer is finished, this is also shown on the DM-24 screen.

#### NOTE

*It is important that the data transfer from a remote device to the DM-24 is not interrupted while it is in progress. If only part of the data is transferred, there is a risk that the library contents, etc. will be corrupted and become unusable.*

---

### Updating the system software

This is a special case of bulk data transfer. Periodically, TASCAM makes upgrades to the DM-24 available through your TASCAM dealer. Consult your dealer, or the TASCAM Web site, for details of these upgrades.

The software is provided in the form of a standard MIDI file which must be dumped if it was a song being played from a MIDI sequencer to the DM-24.

To update the system software:

- 1 Turn off all audio devices connected to the DM-24. As the DM-24 resets itself after the software has been updated, this may cause unwanted “thumps”, etc. in the audio chain.**
- 2 Connect the MIDI IN of the DM-24 to the OUT of the remote device.**
- 3 On the BULK screen, move the cursor to the PROGRAM VERSION UPDATE [READY] button and press ENTER.**

**A popup message appears. The update procedure can be cancelled at this stage by pressing a cursor key.**

- 4 Start the “playback” from the remote device. The screen shows that a MIDI file dump is taking place and what data is currently being transferred. It provides an indication of the transfer process by blinking.**

#### WARNING

*It is MOST IMPORTANT that you do not turn off the power or otherwise interrupt the transfer of data while a system update is taking place. If the transfer is interrupted, it is almost certain that the DM-24 will be unusable.*

**The DM-24 resets itself when the data has been transferred successfully. After the reset, the other audio devices can be turned on again.**

---

### Control Change messages to and from the DM-24

As well as being able to send Control Change messages (as described in “MIDI controllers” on page 93), the DM-24 is also able to send and accept Control Change messages to and from a MIDI device using the audio faders, pan settings and **MUTE** keys of the channels, and the faders and **MUTE** keys of the master channels.

Although the Control Change messages received do not provide full remote control of the DM-24, this does allow for some useful functions.

For example, a sequencer can be used to mute and un-mute channels precisely in sync with the musical timing of a piece, rather than by timecode values.

The Control Change messages transmitted in this way can also be used to make settings on remote MIDI devices in time with fader movements, etc.



## 12 – MIDI—Control Change messages to and from the DM-24

To access this facility, use the CTRL. CHANGE (Control Change) screen of the MIDI/MC group, with the fourth soft key providing access to this screen:

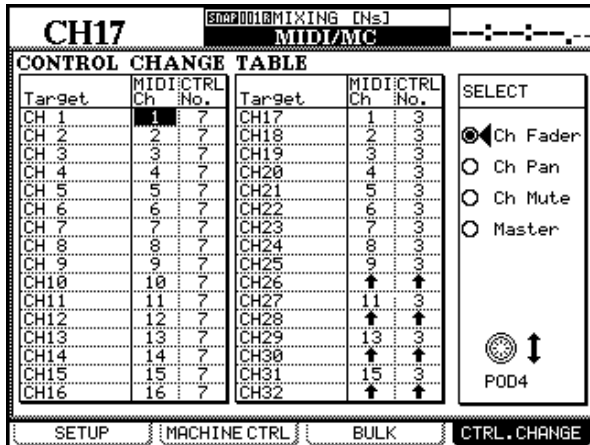

Use POD 4 to choose the option that will be affected by the selected Control Change numbers.

Since there are 32 channels and only 16 MIDI channels, there must be some mapping performed. It is not possible, for example, to use the MIDI volume Control Change (07) to affect the fader values of all 32 channels of the DM-24.

As shown here, each target (channel and value) is associated with both a MIDI channel and a MIDI Control Change number. These are edited using the cursor keys, dial and **ENTER** key.

### NOTE

The following Control Changes are not available for use with this function: 0, 6, 32, 38, and 96 through 127.

If two channels have been linked, the even-numbered channel of the pair is represented by upward-pointing arrows, and no assignment can be made to it, since it will use the assignment of the odd-numbered member of the pair.

If a MIDI Channel/Control Change combination has already been used, a popup message appears (MIDI Chx [Control No. y] is already assigned.). Press **ENTER** to dismiss this popup message.

The above assignments apply to the first three options: Ch. Fader (fader), Ch. Pan (pan) and Ch. Mute (mute). For the other options, the situation changes a little:

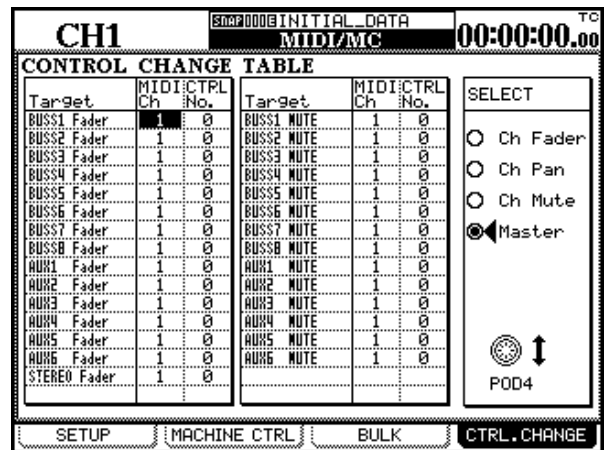

If the Master option is selected, the fader values and mute settings for the buss and for the aux sends are displayed, as well as the main STEREO fader value.

Assign MIDI channels and Control Change numbers to these parameters.

# 12 – MIDI—MIDI Implementation Chart

## MIDI Implementation Chart

TEAC [Digital Mixer]

DATE : 25 June, :2001

Model:DM-24

MIDI Implementation Chart

Version : 1.0

Function		Transmitted	Recognized	Remarks
Basic Channel	Default	1-16	1-16	Memorized
	Changed	1-16	1-16	
Mode	Default	x	x	
	Messages	x	x	
	Altered	*****	x	
Note Number	True Voice	x	x	
		*****	x	
Velocity	Note On	x	x	
	Note Off	x	x	
After Touch	Key's	x	x	
	Ch's	x	x	
Pitch Bend		x	x	
Control Change	1-5, 7-31, 64-95	O	O	Assignable *1, *a
	0, 6, 32-63-96-119	x	x	
	1-2, 4-5, 7-8, 10-13, 16-19	O	O	*b
	64, 67, 84, 99, 101	O	O	
	0, 3, 6, 9, 14-15, 20-63	x	x	
65-66, 68-83, 85-98, 100	x	x		
102-119	x	x		
0-119	O	O	*c	
Prog Change	True #	O (1-127)	O (1-127)	Assignable, *1, *b
		*****	*****	
System Exclusive		O	O	*1, *3
Common	MTC Quarter Frame	O	O	*1
	Song Pos	x	x	
	Song Sel	x	x	
	Tune	x	x	
System Real Time	Clock	x	x	
	Commands	x	x	
Aux Messages	Local ON/OFF	x	x	
	All Notes OFF	x	x	
	Active Sense	O (*1)	O	
	Reset	x	O (*1)	

\*a.Capable of being enabled or disabled

\*b.Snapshot, Effect1, Effect2

\*c.Bulk Dump (MFD Header, MFD Data Packet, MFD EOF) MMC, MTC Full Message, Device Enquiry

\*a.Fader, mute, pan effect settings with the Control Change on the MIDI screen

\*b.Usable with the MIDI Controllers display

\*c: Usable with the MIDI Faders display

MODE 1: OMNI ON, POLY

MODE 2: OMNI ON, MONO

O:Yes

MODE 3: OMNI OFF, POLY

MODE 4: OMNI OFF, MONO

x: No

The DM-24 allows storage of commonly-used settings in libraries.

The settings that can be stored are:

- Snapshots
- EQ settings
- Internal effector settings (separate groups for effectors 1 and 2)
- Internal dynamics processor settings (both compressor and gate/expander)
- Automation data

The procedure for working with all of these *libraries* is very similar (except for the automation library,

which has various different features and is explained in the automation manual).

For all the libraries, practically all the administration can be carried out from a single screen.

The dedicated **LIBRARY** keys (**–**, **+**, **RECALL** and **STORE**) to the immediate left of the display do not work with the automation data. As explained in “LIBRARY DIRECT KEY OPERATION” on page 20, these keys can be set up to work with any of the libraries above except for the automation data.

If we make reference to the library which is selected for use with the dedicated keys in this way, we refer to it as the *active library*.

## Library concepts

Each library contains a number of different locations as follows:

Library	Total locations	Read-only locations
Snapshots	100	1
EQ	128	20
Effect 1 (P1)	128	128
Effect 2 (P2)	128	128
User effect library (U1)	128	0
Compressor	128	18
Gate/Expander	128	2
Automation	7	–

In most of the libraries, several locations are reserved as read-only, with the settings in these locations being set up containing useful pre-set values.

The effect libraries are divided into two types: preset (P), where none of the locations can be overwritten, and a user library (U), where all locations can be used for storing user settings. See the separate effects manual for further details.

On the screen, a read-only location is displayed with an inverse R (as is snapshot 000 in the screen below):

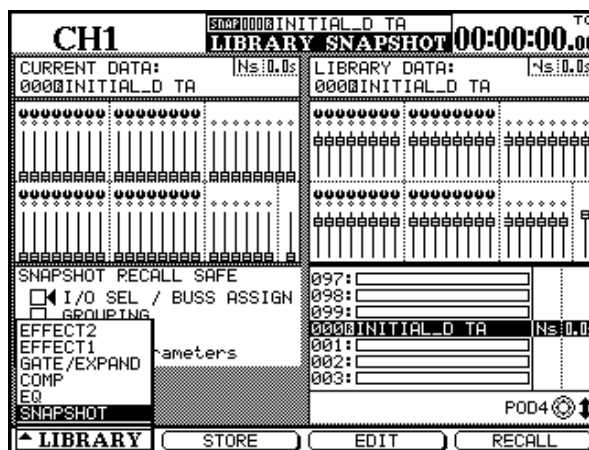

Use these read-only settings “as-is” as presets, or use them as starting points for experimentation.

If you try to store your own settings to any of these read-only entries, an appropriate popup error message appears.

## Managing library entries

Library entries can be stored, recalled and edited (including the addition of meaningful alphanumeric names).

### Storing active library entries

When a library has been set as the active library, with direct key operation enabled, storing the current setting of that library is carried out in the following way from other screens:

- 1 Use the **+** and **–** keys to the left of the display to change the library entry number shown at the top of the screen.
- 2 Press the **STORE** key below the **+** and **–** keys to store the current settings to the library.

## 13 – Library functions—Managing library entries

If the currently-selected entry is read-only (the inverse R is shown), an appropriate error message is displayed and the data is not stored.

If data already exists in the library entry, a popup message appears to show that data is already there and will be overwritten.

- 3 In the case of overwriting an existing entry, press **ENTER** to overwrite the entry, or any of the cursor keys to cancel the operation.

---

### Storing entries in a non-active library

When a library has not been set as active, the dedicated library screen must be used.

- 1 With the **SHIFT** indicator off, press **LIBRARY** (key 7 on the numeric keypad). The screen corresponding to the last library used appears.
- 2 To change the library, press soft key 1 so that a pull-up menu containing the different libraries appears. Turn **POD 1** to highlight the library that is to store the data, and press **ENTER**.

The screen changes depending on the selected library, as a “preview” of the selected entry is shown, and the way in which this preview is displayed changes according to the library.

- 3 Use **POD 4** to scroll up and down through the list of entries. Read-only entries are marked, and entries which contain data are titled.
- 4 When the entry where the current data is to be stored is highlighted, press the second soft key (**STORE**) or the dedicated **STORE** key.

If the currently-select entry is read-only (the inverse R is shown), an appropriate error message is displayed and the data is not stored.

If data already exists in the library entry, a popup message appears to show that data is already there and will be overwritten.

- 5 Overwrite existing entries using the **ENTER** key.
- 6 When a library entry is to be stored, it must be named. See below for details of naming entries.

---

### Loading entries from an active library

When a library has been made active, you can recall entries in the library from almost any screen.

- 1 Use the **+** and **-** keys to the left of the display to change the library entry number shown at the top of the screen.
- 2 Press the **RECALL** key below the **+** and **-** keys to recall the library entry and overwrite the current settings.

If there is no data in the library entry, a popup message appears to show this, and no data is recalled.

#### **NOTE**

*Recalling library entries, especially if you are unsure of the contents of the entry, may result in unexpected changes of volume. Be prepared for this, and turn down the monitoring system to avoid damage to your ears (and the monitoring equipment) if you feel that this may be a problem.*

---

### Loading entries from a non-active library

- 1 With the **SHIFT** indicator off, press **LIBRARY** (key 7 on the numeric keypad). The screen corresponding to the last library used appears.
- 2 To change the library, press soft key 1 so that a pull-up menu containing the different libraries appears. Turn **POD 1** to highlight

the library that is to store the data, and press **ENTER**.

The screen changes depending on the selected library, as a “preview” of the selected entry is shown, and the way in which this preview is displayed changes according to the library.

# 13 – Library functions—Managing library entries

- 3 Use **POD 4** to scroll through the list of entries in the library.
- 4 Press soft key 4 or the dedicated **RECALL** key to recall the entry.

If there is no data in the library entry, a popup message appears to show this, and no data is recalled.

## Library undo/redo

When library entries are recalled (“Library functions” on page 99), the **2ND F.** key pressed together with the **RECALL** key acts as an undo key, allowing

the recently recalled library setting to be compared with the previously-loaded library setting.

## Setting and editing titles

The DM-24 provides titling facilities for the library entries. These are available when an entry is first stored, or when the **EDIT** soft key (3) is pressed from the library screen.

Library entries may have a name consisting of up to 16 characters.

Use the cursor keys to navigate the cursor around the name editing area on the left of the screen.

Pick letters and symbols from the list below the name editing area. Press **ENTER** to insert the highlighted symbol into the name editing area.

It is also possible to use the **SCREEN MODE/ NUMERIC ENTRY** keys to enter numbers directly into the title.

Use the special commands as follows:

**INSERT** – inserts a space at the cursor position

**DELETE** – deletes the character at the cursor position

**<-NAME** – as explained above, this copies the existing name of the highlighted data entry to the name editing area.

**NAME->** – this copies the edited name to the highlighted entry in the list at the right of the screen.

**Xtion->** and **<-Xtion** – **snapshots only**. This is not part of the name, but represents the transition time to load a snapshot. This is edited using **POD 2** and can be set from 0.0 seconds to 9.9 seconds, in 0.1 second intervals. Use these two on-screen options to move the transition time from and to the editing area, respectively.

When the name is edited, use the **STORE** soft key (2) to store the name (and the transition time in the case of snapshots). Note that this does not store the snapshot, but only the name, etc.

Use the **CANCEL** soft key (3) to cancel the name editing operation.

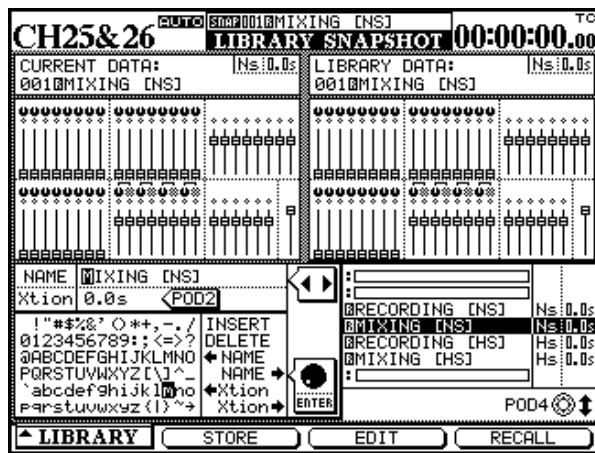

Use **POD 4** to scroll through the list of library entries.

When a library entry is stored it is given a default name (for instance FROM CH12 would be used to describe an EQ setting which had been saved from the current settings on channel 12).

If the entry highlighted in the list at the right of the screen already has a name which is to be edited, use the dial to pick the **NAME** special command and press **ENTER**. This copies the entry name to the name editing area.

## Libraries—snapshots

There are a few items regarding the snapshot library which should be noted:

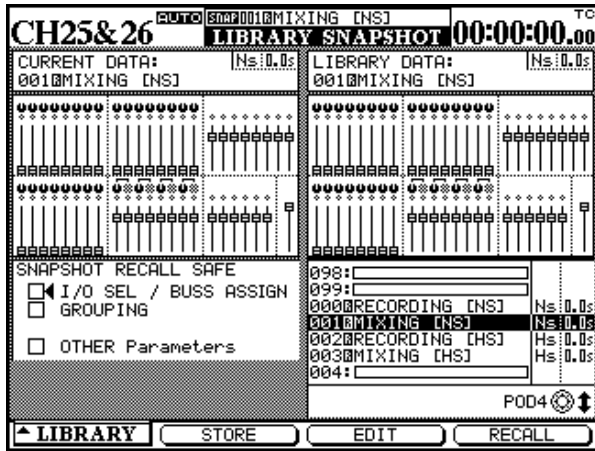

The snapshot library screen includes a picture of the faders, together with pan/balance settings and mute settings.

However, the snapshot itself comprises more than this. All the parameters listed in “Snapshot “neutral” setting” on page 102 are stored in a snapshot.

As the list on the right of the screen is scrolled using POD 4, the snapshot image on the right changes to show the setting stored in that entry.

The snapshot image on the left shows the current data.

As well as the snapshot name itself, the entry also stores whether the snapshot was made at high (96k or 88.2k) or normal sampling frequency.

### NOTE

*It is not possible to recall a snapshot made at a high sampling frequency when the DM-24 is in normal sampling frequency mode, or the other way round.*

The transition time is also displayed (in seconds). See above for how to set and store this time.

## Protecting snapshot settings

It is possible to protect various aspects of the setup, to prevent the recalled snapshot from overwriting them. This means that only the “important” parts of a snapshot can be used—for example, the I/O and buss assignments can be retained and not overwritten by the snapshot.

**I/O SEL / BUSS ASSIGN** If this is checked, it allows the I/O selection “Setting up the I/O” on page 36 to be retained, as well as the buss assignment settings.

**GROUPING** If this is checked, when the snapshot is recalled, the mute and fader groupings are retained.

**OTHER** If this is checked, other settings will be retained when a snapshot is recalled.

### NOTE

*If all these boxes are checked, no settings will be changed when a snapshot is recalled.*

## Snapshot “neutral” setting

The snapshot read-only entry is a “neutral” setting.

All faders are set to nominal levels, and pan controls are set to center, etc.

Specifically

Item	Value
EQ switch	ON
EQ gain (all bands)	0dB
EQ frequency (LO/LM/LH/HI)	99 Hz/1 kHz/4 kHz/10.1 kHz
EQ Q (LO/LM/LH/HI)	L.SHELF/8.65/8.65/H.SHELF
Fader level	0dB
Cut	OFF
Aux send levels (all)	−∞
Aux pre/post (Aux 1,2 only)	POST

Item	Value
Aux ON/OFF	ON
Pan/BAL	CENTER
Image width	STEREO100%
MONO switch	STEREO
Surround L-R	CENTER
Surround F-R	F45
Surround L-R Div	100%
Surround F-R Div	100%
SUB level	0dB
Aux master levels	0dB
Aux master link	OFF
Aux master cut	OFF
Buss level	0dB

Item	Value
Buss links	OFF
Buss cuts	OFF
Dynamics on/off	OFF
Dynamics type	COMP
Dynamics parameters	
THRESH/RATIO/ATTACK/ RELEASE/OUTGAIN/AUTO- MAKEUP	0dB/ -∞:1 /5ms/5ms/0dB/OFF
Dynamics links	OFF (except for ST IN 1 and 2)
Dynamics trigger (not shown as link is off)	BOTH
Effect in	0dB
Link	OFF
Pad level	0dB
Phase switch	Normal
Pan gang	OFF
Sample delay	0sample
Delay switch	OFF
Buss assignments	No Assign
Stereo/direct assignments	(St:ON)/(Dout:OFF)
Surround assignments	(Srnd:ON)/(Sub:OFF)
Cut group	No Assign
Fader group	No Assign
Snapshot name	INITIAL-DATA

## Libraries—effects

When the internal effect library is selected, the screen display changes as shown below:

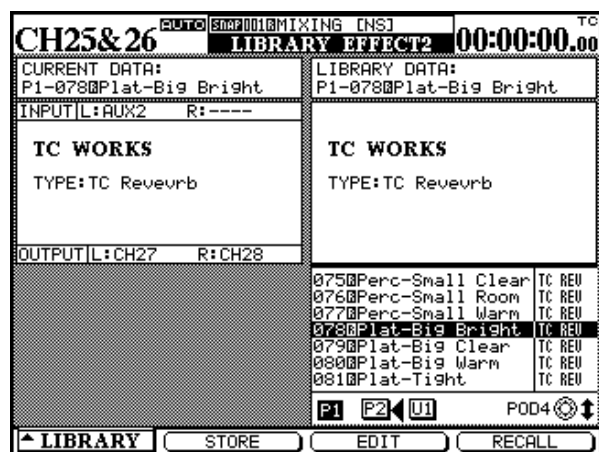

This differs from the other libraries, because it is possible to access four different sub-libraries from a single screen.

The settings for the current and the library entry data effector are displayed on the left and the right of the screen respectively. In addition, the current effector setting (either 1 or 2, as determined by the currently-

selected sub-library) also shows the input to and the output from the effector.

The sub-libraries are:

- Preset entries for effect 1 (P1)
- Preset entries for effect 2 (P2)
- User entries (U1)

To change the sub-library:

- 1 Use the cursor keys to select the sub-library.
- 2 Press the ENTER key to select the sub-library.

Use the normal procedures to store, recall and name the effector entries.

Preset entries can be recalled, and then edited and stored in the user sub-library.

Obviously, read-only preset entries cannot be overwritten by user entries.

In addition to the name of the entries stored in the library, the type of effect is also shown beside the name. This type is automatically entered when the

# 13 – Library functions—Libraries—dynamics processors

effect is stored, and cannot be changed or edited in any way.

See the separate effects manual for further details.

## Libraries—dynamics processors

There are two separate sets of dynamics processor, which are very similar to each other in terms of operation, and so are described together here:

The first is the compressor set:

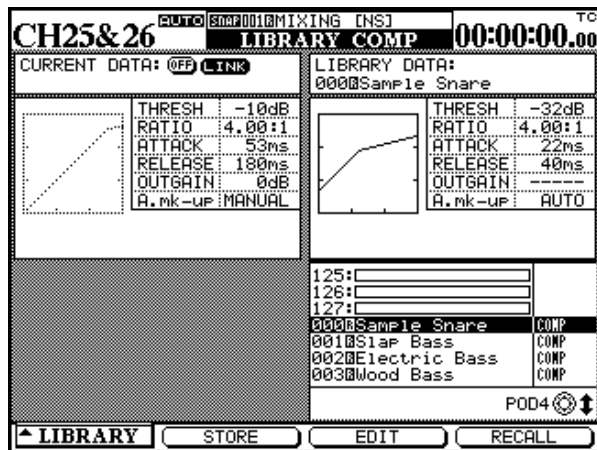

The other set is the expander/gate set:

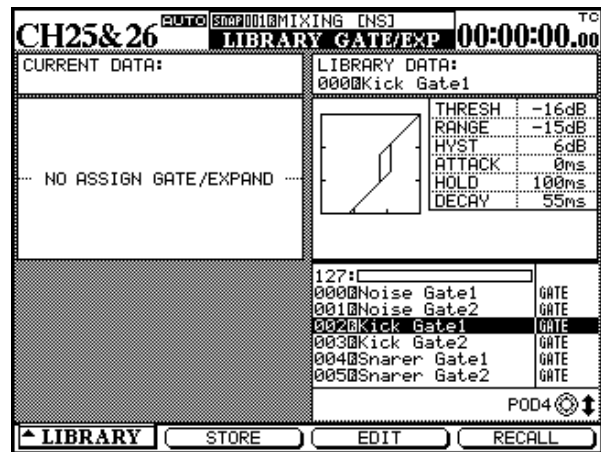

These two sets differ only in the fact that the parameters for these dynamics processors vary, and accordingly the screen display of the current settings and the library entries reflect this.

It is not possible to store a compressor setting into the expander/gate library, or the other way round. However, expanders and gates may be mixed in the expander/gate library.

The type of dynamics processor which is stored is shown to the right of the title in the list. This cannot be edited or changed.

The store, recall and edit functions are as described earlier in this section (“Managing library entries” on page 99).

## Preset dynamics entries—compressors

The titles of these compressor preset settings are intended to give an idea of the kind of signal for which they have been designed. However, this is only a guide, and you should experiment with these set-

tings, and variations of these settings, in different contexts in order to discover the best sounds for your purposes.

Number	Title	Comment
000	Snare drum	Sampled snare drum setting
001	Slap Bass	Suitable for slap bass sounds
002	Wood Bass	Suitable for upright plucked double bass
003	Synth. Bass 1	For synth bass sounds
004	Synth. Bass 2	



Number	Title	Comment
005	Acoustic Guitar	Acoustic guitar compression
006	Ele. Guitar 1	For electric guitars
007	Ele. Guitar 2	
008	Ele. Guitar 3	
009	Brass	For brass sections
010	Vocal 1	For vocals
011	Vocal 2	
012	Total Comp 1	Overall “blanket” compression settings
013	Total Comp 2	
014	Total Comp 3	
015	Post Pro.1	Useful in post-production work
016	Post Pro.2	
017	Narration	Useful setting when recording narrations

## Preset dynamics entries—gates

Two noise gates are provided as starting points for experimentation:

Number	Title	Comment
000	Snare drum	Sampled snare drum setting
001	Slap Bass	Suitable for slap bass sounds

## Libraries—EQ

The EQ library provides preset and user settings.

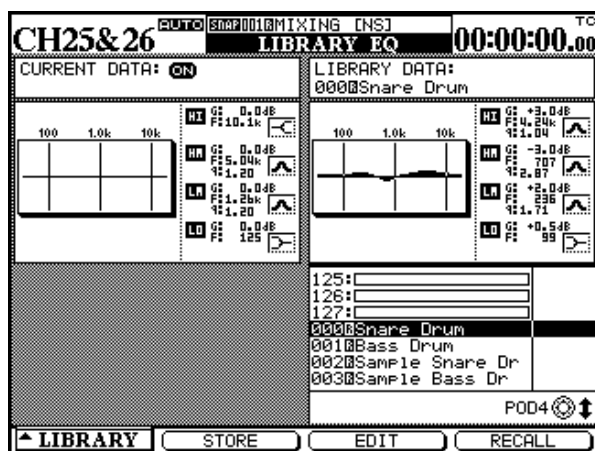

As well as the graphical representation of the equalization curve for both the current settings and the library entry, the numerical values of the gain, frequency and Q for each of the four frequency bands are displayed.

In addition, a small icon beside each band's figures indicates whether the EQ band has been configured as a shelving, peaking, notch or LPF or HPF filter.

Storing, editing and naming, and recall operations are all as described in “Managing library entries” on page 99.

## 13 – Library functions—Libraries—EQ

### Preset EQ entries

The following are provided for use, and also as starting points for experimentation and creating original EQ settings

Number	Title	Comment
00	Snare Drum	Suitable for a snare drum
01	Bass Drum	Suitable for kick (bass) drum
02	Sample Snare Dr.	EQ for a sampled snare sound
03	Sample Bass Dr.	For a sampled kick (bass) drum sound
04	Wood Bass	Upright plucked double bass
05	Synth. Bass 1	For synth bass sounds
06	Synth. Bass 2	
07	Acoustic Guitar	Suitable for acoustic guitars
08	Ele. Guitar 1	For electric guitars
09	Ele. Guitar 2	
10	Ele. Guitar 3	
11	Violins & Violas	For the upper instruments in a string ensemble
12	Cello & C.Bass	For the lower instruments in a string ensemble
13	Brass	For brass sections
14	Piano	Acoustic piano setting—starting point for experimentation
15	Pad fits to VOX	For “pad” sounds to match vocals
16	Vocal 1	Vocal EQ starting points
17	Vocal 2	
18	Hum Cancel	Elimination of AC (mains) noise
19	Radio Voice	“Squawk-box” vocal setting

In addition to normal stereo operations, the DM-24 is also capable of producing surround mixes in a variety of formats.

Because the DM-24 is capable of mixing to several different surround modes, some of the operations and display screens are slightly different from the “normal”, stereo mode, as explained here.

Some of these operations are also explained in other parts of the manual, but are gathered here for easy reference.

In all cases where a surround mode is selected, the output busses are used to control the levels of the signals sent to the different channels of the surround matrix.

## Selecting a surround mode

This selection is made through the PAN/BAL SURROUND MODE screen:

- 1 Make sure the **SHIFT** indicator is off, and press the **PAN/BAL SURROUND** key until the following screen is shown (or press soft key 1):

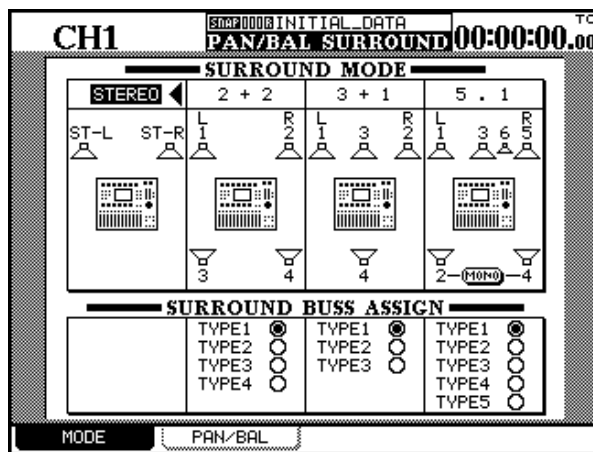

- 2 Use the cursor keys and the **ENTER** key to highlight and select the stereo mode or a surround mode from the following:

STEREO	One left and one right speaker, output through the stereo output buss
2 + 2	One front left speaker and one front right speaker, with a pair of rear speakers (left and right)
3 + 1	A pair of front left and right speakers, together with a front center speaker and a center rear speaker
5 . 1	A pair of front left and front right speakers, with a front center speaker. A pair of rear left and rear right speakers is also provided, as is a sub channel (typically placed front center)

A popup screen appears, allowing you to confirm the new setting, or cancel it.

A plan view of the speaker layout is shown on the display screen.

Note that in the 5.1 screen, the two rear speakers can be selected as a single mono output.

## Monitoring surround patterns

The output busses are used to control the levels of signals sent to the surround matrix channels. In this context, they can be regarded as master “surround pan” controls.

For monitoring, therefore, it is necessary to have an analog output for each output buss used. This is most

easily achieved using the analog I/O slot card (IF-AN/DM). This allows easy connection of an analog multi-channel monitoring system to the DM-24.

The assignment of the busses to the channels is shown by a number beside the representation of the on-screen speakers.

# 14 – Surround operations—Assigning modules

## Selecting a buss pattern

The surround buss assignments below each surround mode type allow the assignment of different buss patterns to the surround channels. Where a channel does not exist as part of a surround mode pattern, it is represented by a dash (-).

Surround mode	Buss Assign Type	Output buss used for:						
		Front Left	Front Center	Front Right	Rear Left	Rear Center	Rear Right	Sub
2+2	1	1	—	2	3	—	4	—
	2	1	—	3	2	—	4	—
	3	1	—	4	2	—	3	—
	4	1	—	2	4	—	3	—
3+1	1	1	3	2	—	4	—	—
	2	1	2	3	—	4	—	—
	3	1	2	4	—	3	—	—

Surround mode	Buss Assign Type	Output buss used for:						
		Front Left	Front Center	Front Right	Rear Left	Rear Center	Rear Right	Sub
5.1	1	1	3	5	2	—	4	6
	2	1	3	2	5	—	6	4
	3	1	2	3	4	—	5	6
	4	1	5	2	3	—	4	6
	5	1	2	3	5	—	4	6

This facility allows the selection of a fader pattern that suits your individual way of working or allows your surround to correspond to the surround buss assignments of another piece of equipment in the system.

## Assigning modules

When a surround mode has been selected, the ASSIGN BUSS screen changes so that the usual buss assignments are not shown, but the modules are now assignable to the surround channels:

The screen below shows the 2+2 surround assignment settings

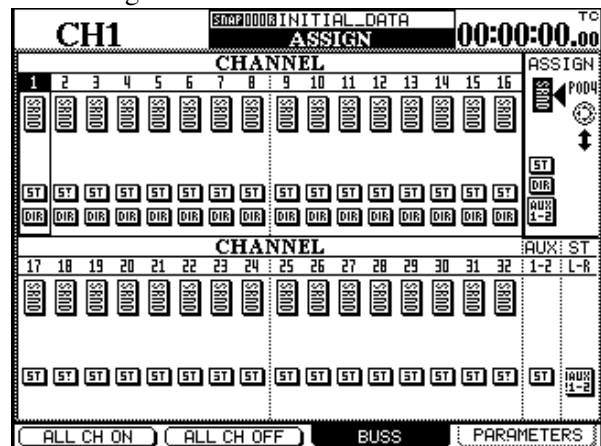

# 14 – Surround operations—“Pan” controls

The screen below shows the 3 + 1 surround assignment settings.

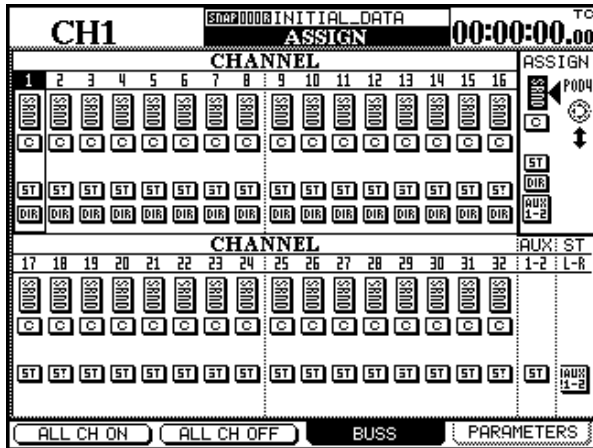

The following screen shows the 5.1 surround assignment settings.

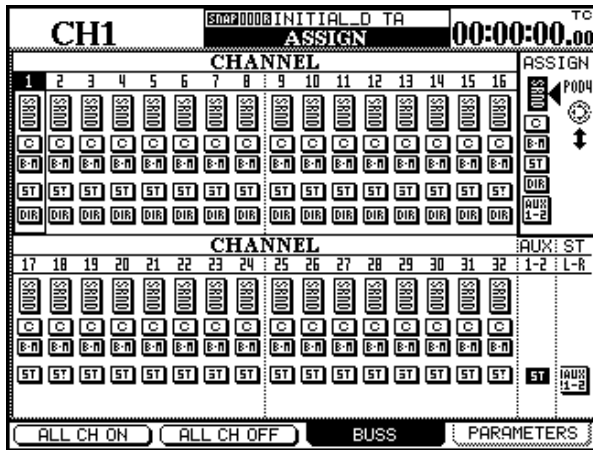

In these screens, the four buss pairs are replaced by buttons representing the front and rear pairs of speakers (SRND) and the center speaker (C) for the 3 + 1 and 5.1 modes. The 5.1 mode also includes a buss for the sub-woofer or “boom” speaker (B-M).

The channel can also be output through the usual stereo buss (ST).

As in the usual assignment procedure, channels 1 through 16 are also capable of direct output.

Use the **SEL** keys and cursor keys to select the channel, and POD 4 to select the output channel, and make and un-make assignments to the channels using the **ENTER** key.

Soft keys 1 and 2 are used for on-screen buttons, allowing all channels to be assigned to or de-assigned from the routing selected by POD 4.

## “Pan” controls

The concept of panning does not apply to surround mixes as it does to stereo mixes.

Accordingly, when a surround mode is selected, the MODULE screen shows the pan control only for the left-right pan setting.

To make other surround settings, use the SURROUND screen.

This screen is accessed by pressing the **PAN/BAL – SURROUND** key. Instead of a global screen showing

all modules, the surround screen for the currently-selected module and one other module is shown.

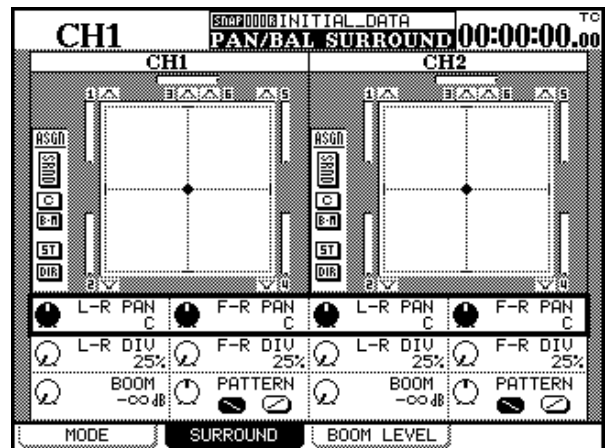

If a pair of modules has been linked as a stereo pair, the stereo linking does not apply to the surround set-

## 14 – Surround operations—“Pan” controls

tings—each module’s (or channel’s) position in the surround image is set independently. However, the fact that these modules have been linked is shown by a & following the module number at the top of the screen.

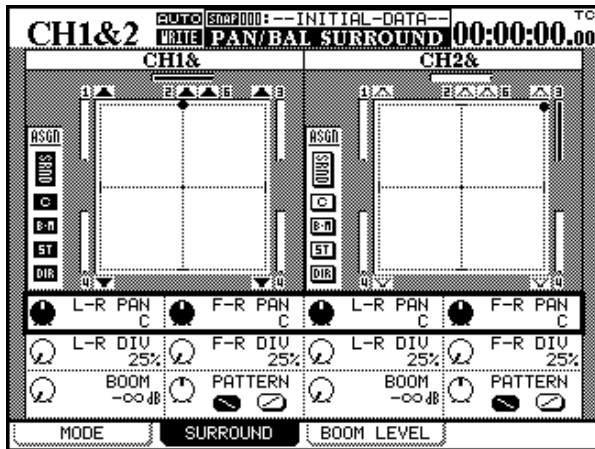

To change the module to be edited, use the **SEL** key of the channel to be edited.

Each channel is shown as a “dot” cursor on a plan of the current surround mode.

The crossing point of the cursor (i.e. the position of the module signal in the surround mix) can be changed with the knobs of POD 1 and POD 3 (these adjust the left/right position for the odd and even modules) and the knobs of PODs 2 and 4 are used to adjust the position from front to rear. These adjustments are made when the row cursor is highlighting the top row on the screen.

For the left/right settings, there are 201 steps, so the left/right setting goes from L through L99 through C (center) through R99 to R. The front/rear settings go from F50 through C (center) to R50.

There is another parameter, which determines the amount of the total “sound-stage”, taken from the center position, within which the module signal can be positioned. This is set using the second row of on-screen PODs.

The values here are set in 4 steps: 25% (the most tightly focussed, almost a point source near the center), through 50% and 75% to 100% (the whole of the sound-stage is available).

Using these parameters, it is therefore possible to set the position of a signal precisely or loosely in either dimension.

Note also the “bar-graphs” (not meters) by each on-screen speaker, which give an indication of the relative level of the signal to each of the output channels in the surround matrix.

In addition to these positioning controls, in the 5.1 surround mode the sub-woofer level (BOOM) may be set with the knobs of PODs 1 and 3 using the bottom on-screen row of PODs.

Pods 2 and 4 of this row are used to move the signal source diagonally within the surround area (equivalent to turning the L-R and F-R pan controls simultaneously). The diagonal angle is set using the on-screen buttons.

### Global boom levels (5.1 only)

In addition to the individual levels which may be set for the bass speaker (BOOM), there is a global page which allows this level to be viewed and edited for all channels simultaneously:

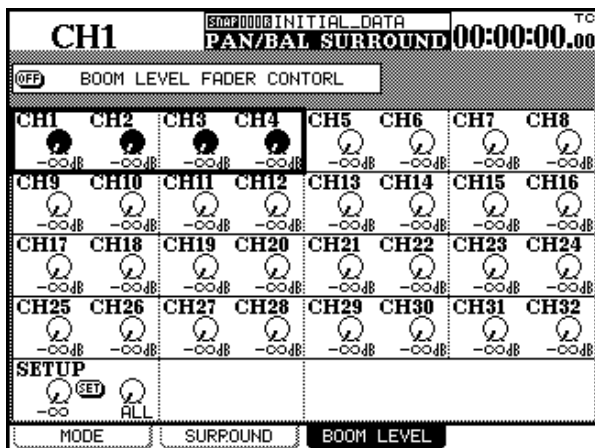

#### NOTE

*This screen is only available in 5.1 mode, as it only has any meaning in this mode.*

- 1 While in the SURROUND screen, press soft key 3 to bring up the boom level display.
- 2 Use the cursor keys to select groups of four channels.
- 3 Use the PODs to edit the levels of the four selected channels.

To set the levels of many channels together:

- 1 Move the cursor to the bottom row of the screen.
- 2 Use POD 2 to change the selection group between ALL (all channels), ODD (odd-numbered channels), EVEN (even-numbered chan-

## 14 – Surround operations—“Pan” controls

nels), 1-8, 9-16, 17-24, 25-32 (blocks of eight channels).

- 3 Use POD 1 to set the level for the selected group.**
- 4 Move the cursor to the on-screen SET button, and press ENTER.**

After making a “global” setting in this way, use the cursor keys and PODs to trim the individual channel levels as desired.

It is also possible to use the faders to control the boom level (use the BOOM LEVEL FADER CONTROL button at the top of the screen, and the faders as described in “Using the faders to change values” on page 14.

## 15 – High sampling frequency

The way in which the DM-24 operates in *high sampling frequency mode* (88.2k and 96k) is slightly different in many cases to the operation in normal sampling frequency mode (44.1k and 48k).

This section describes the differences between high sampling frequency mode and normal sampling frequency mode.

### To select high sampling frequency

Use the **DIGITAL** key (**SHIFT** and **AUX 5-6**), and choose the **CLOCK** screen.

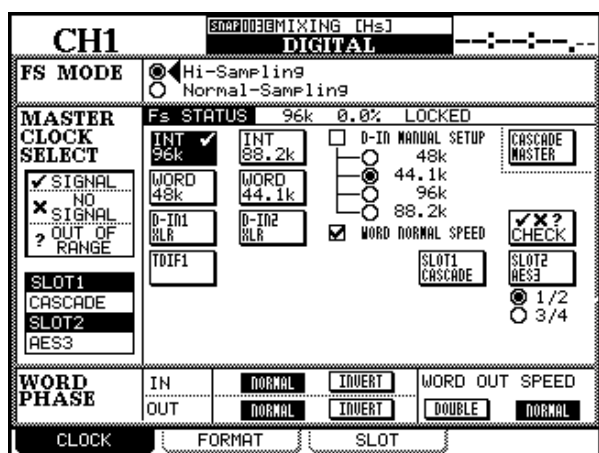

At the top of this screen is the Hi-sampling / Normal-sampling pair of on-screen radio buttons.

Select the Hi-sampling button and press **ENTER**.

Changing from normal to high sampling frequency mode, and the other way round brings up a pop-up

The high sampling frequency can be obtained internally, when the DM-24 acts as the word sync clock for the whole of the audio system, or the DM-24 can act as a word sync slave, taking word sync from other suitably-equipped devices.

message which asks for the DM-24 to be turned off and on again.

The sampling frequencies displayed on the screen as available for use change, as shown here.

#### NOTE

*If other devices are not connected properly, this may cause noise in the monitoring system when the DM-24 restarts. Make sure that all monitoring equipment levels are turned down (or the monitoring equipment is turned off) when making these changes.*

When the high sampling frequency mode is selected, many of the control screens change as explained in this section.

The word sync output from the DM-24 can be set to be **DOUBLE** or **NORMAL** speed in high sampling frequency mode. This may be necessary if the DM-24 is to act as a word sync master to another device that cannot accept double-speed word sync.

#### NOTE

*The DM-24 itself can only accept normal-speed word sync when it is in high sampling frequency mode.*

### Constraints on other devices

When using the DM-24 in high sampling frequency mode, other digital audio devices must be compatible with this mode (that is, they must be capable of accepting and/or transmitting digital audio data at these high sampling frequencies).

Such devices are the TASCAM DA-98HR and the TASCAM MX-2424.

When connecting to other devices via AES/EBU connections made using the optional AES3 slot card, there are some important points to be noted.

The **SLOT** screen of the **DIGITAL** display shows this:

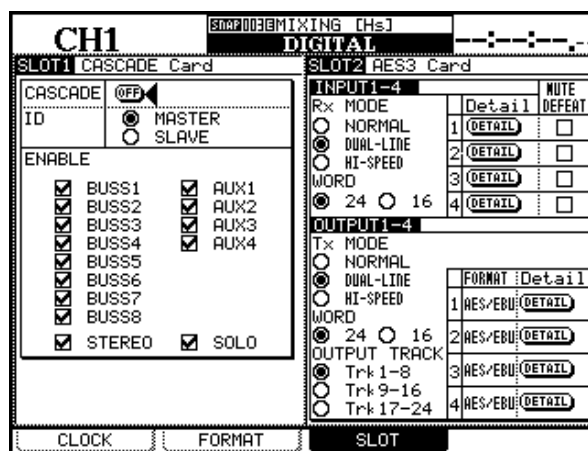

There are two ways in which AES/EBU data can be sent at high frequencies.



## 15 – High sampling frequency—Channels, etc.

DUAL-LINE is a “parallel” method, in which a pair of AES/EBU cables send two channels of high sampling frequency audio data.

HIGH-SPEED uses one AES/EBU cable to send two channels of audio data at twice the standard data rate.

In this screen, the output format of the four AES/EBU input streams available to the DM-24 can be selected to be either high-speed or dual-line, depending on the capabilities of the other equipment connected to the DM-24.

This choice also applies to devices connected to the **DIGITAL IN** and **DIGITAL OUT** ports of the DM-24, as shown here.

CH1 SOURCE 0003 INITIAL DATA INT 00:00:00.00  
DIGITAL

**DIGITAL I/O SETUP**

DIGITAL 1-2 Tx/Rx 1 MODE: DUAL-LINE  
DIGITAL IN1 XLR DIGITAL IN2 XLR  
Fs CONVERT: OFF Fs CONVERT: OFF  
 MUTE DEFEAT (DETAIL)  MUTE DEFEAT (DETAIL)  
DIGITAL OUT1 STEREO  
FORMAT: AES/EBU (DETAIL)

MULTI I/O	SOURCE	INPUT WORD LENGTH	Detail
TDIF 1	BUSS1-8	24bit	(DETAIL)
TDIF 2	BUSS1-8	24bit	(DETAIL)
TDIF 3	BUSS1-8	24bit	(DETAIL)

**STEREO OUT SETUP**  
WORD LENGTH: 24bit

CLOCK FORMAT SLOT

The high sampling frequency format of **DIGITAL IN** and **OUT 1** and **2** must be altered together (they cannot be set independently) and the MODE choice (at the top of the screen, highlighted here) is either NORMAL, DUAL-LINE or HIGH-SPEED.

### NOTE

*These settings can also be made in normal sampling frequency mode, but the frequency conversion must be set to in for this to apply.*

---

### Channels, etc.

---

When high sampling frequency has been selected, the number of channels available is halved, from 32 to 16.

The first sixteen physical faders 1 through 16 are used for this purpose. The fader layer 17-32 has no meaning in the high sampling-frequency mode.

Twelve channels are available for mic/line input, and a further four for channel input.

The number of aux sends is also reduced, from 6 to 4.

However, the number of busses is unchanged at 8.

Also note that the number of AES/EBU channels available on any installed slot cards is now halved.

The number of onboard compressors and dynamics processors, etc. is also reduced.

However, the functionality of the components that make up the modules (EQ, etc.) is not impaired or reduced.

## High sampling frequency I/O

The following explains how the I/O assignments are changed when high sampling frequency is selected.

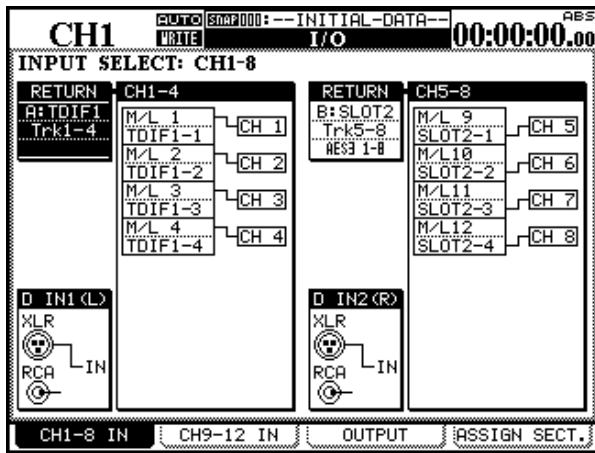

Instead of being divided into groups of eight, as in the usual assignment screens (“Setting up the I/O” on page 36), these are selected using groups of four, as shown in the figure above.

Eight channels are shown on screen at one time.

The second group of eight channels (the second four of which cannot accept signals from the mic/line inputs) is shown here:

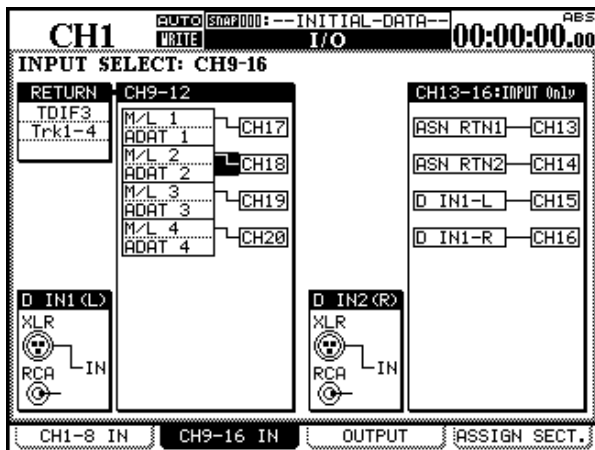

Note how the usual eight channels of the TDIF connectors are reduced to four in this mode.

The output screen changes as shown here, as only four output channels are available on each output

groups. The eight output busses are therefore split between two groups (the first four going to the first group selected, and the second four to the second group). The number of direct outputs is also reduced in this mode, from 16 to 8.

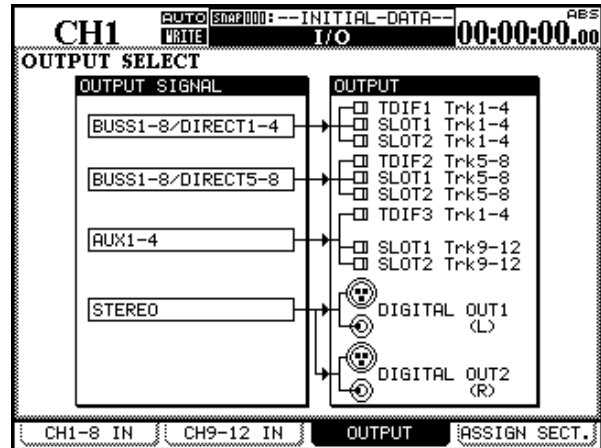

Finally, the screen in which the assignable sends are used in high frequency sampling mode differs slightly from the usual:

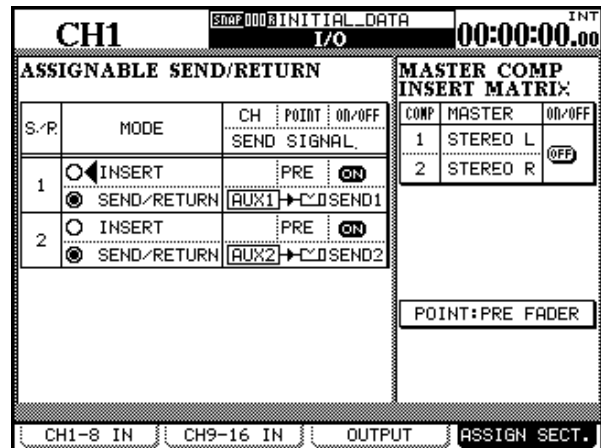

There are only two assignable sends and returns (the physical connectors used here are 1 and 2).

Only two channels of master compressors are available in high sampling frequency.

In other respects, this screen operates in the same way as its normal sampling frequency counterpart.

## Monitoring

The monitoring system in this mode is very similar to the normal mode:

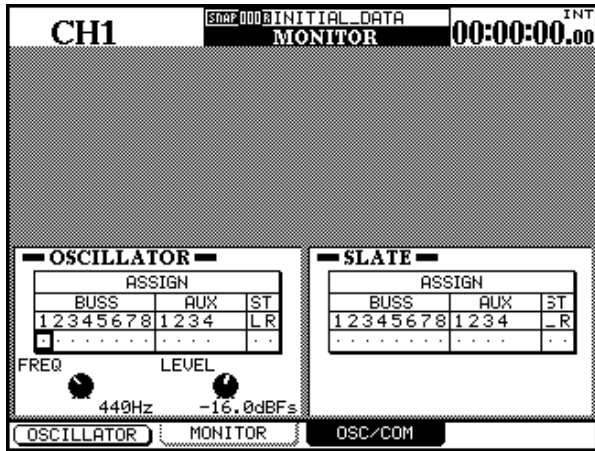

The difference is in the choice of the destinations for the oscillator and the talkback slate (there are only four aux sends available for the destination). See “Slate settings” on page 77 and “Lineup oscillator” on page 77 for further details of slate and oscillator operations.

## Aux sends

Since there are only four aux sends, the aux send screens change. For instance, the module Aux screen is slightly “stripped down” to show only four Aux sends.

When the **AUX 5-6** key is pressed and the DM-24 is in high sampling frequency mode, the key has no effect.

When either **AUX 1-2** or **AUX 3-4** is pressed, only sixteen channels are shown on screen.

## Channel stereo linking

When the DM-24 is in high sampling frequency mode, the channel linking screen (“Linked modules” on page 60) looks slightly different from the usual screen:

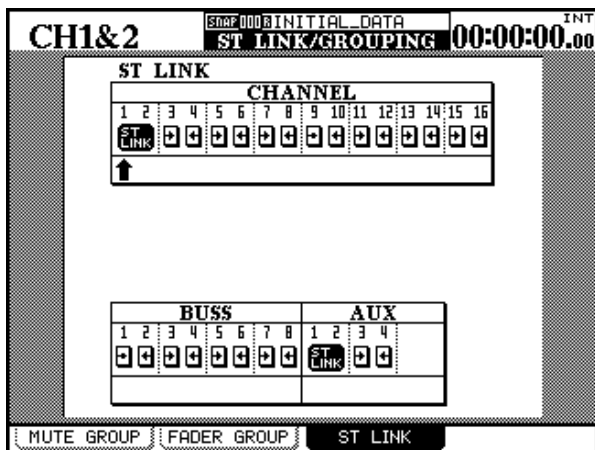

As can be seen here, there are only 16 channels available, and four aux sends.

Links are made and unmade in the same way as in normal sampling frequency mode.

# 15 – High sampling frequency—Grouping

## Grouping

Mute and fader groups are displayed also slightly differently on account of the reduced number of channels, as shown here:

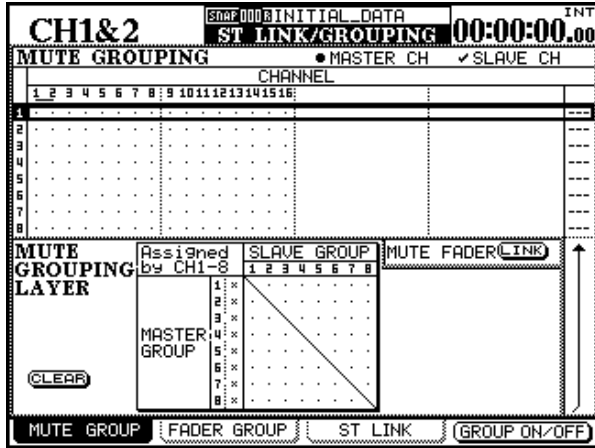

The mute grouping is shown here, but the fader grouping is almost identical.

When the change is made between high sampling frequency and normal sampling frequency modes, the console reverts to “neutral settings” and the current groupings are no longer valid.

For details of how to operate these facilities, see “Grouping” on page 69.

## Trim and delay

The trim screen shows 16 channels, and the delay screen shows 12 channels, rather than 32.

Also, note that the range for delay times remains the same, even though the sampling frequency is different.

## Libraries

Because of the different configuration of the DM-24 in normal and high sampling frequency modes, it is not possible to use a normal frequency snapshot in high sampling frequency mode, or the other way round.

Snapshot library entries are marked with an Hs (high sampling) or Ns (normal sampling) beside their names in the list of library entries on the library screen.

An appropriate popup message is displayed if an attempt is made to load a different kind of snapshot library entry, and the load fails.

However, note that it is possible to store dynamics processor, effects and equalization library entries in one sampling frequency mode, and recall them for use in the other mode.

## Other screens

Throughout the operation of the DM-24, whenever a normal sampling frequency screen displays 32 channels, or provides facilities for 32 channels, in high-frequency mode this will be halved to 16.

CH1																METER/FADER		
CHANNEL																		
OVER	1	2	3	4	5	6	7	8	9	10	11	12	13	14	15	16	L	R
-1																	1	1
-4																	4	4
-8																	8	8
-12																	12	12
-16																	16	16
-20																	20	20
-24																	24	24
-28																	28	28
-32																	32	32
-36																	36	36
-40																	40	40
-44																	44	44
-48																	48	48

METERING POINT		METER LAYER		ST	
CHANNEL	<input checked="" type="radio"/> INPUT	<input type="radio"/> MTR1-12 Follows	<input checked="" type="radio"/> CH1-16	L	R
	<input type="radio"/> PRE		<input type="radio"/> MASTER	OVER	OVER
	<input type="radio"/> POST			1	1
MASTER	<input type="radio"/> INPUT	<input checked="" type="checkbox"/> SEL Key Follows Fader Layer		4	4
	<input type="radio"/> PRE	<input checked="" type="checkbox"/> METER Follows SEL Key		8	8
	<input checked="" type="radio"/> POST			12	12
				16	16
				20	20
				24	24
				28	28
				32	32
				36	36
				40	40
				44	44
				48	48

METER   FADER   MASTER M/F   SETUP

For example, in this screen, the meter layer cannot follow channels 17 through 32 (they do not exist) and therefore the option is not available.

Also, since there are only four aux sends available in high sampling frequency mode, all screens which refer to the aux channels (such as the one below) reflect this.

BUSS1												METER/FADER		
BUSS								AUX						
OVER	1	2	3	4	5	6	7	8	1	2	3	4	L	R
-1													1	1
-4													4	4
-8													8	8
-12													12	12
-16													16	16
-20													20	20
-24													24	24
-28													28	28
-32													32	32
-36													36	36
-40													40	40
-44													44	44
-48													48	48

METERING POINT		METER LAYER		ST	
CHANNEL	<input checked="" type="radio"/> INPUT	<input type="radio"/> MTR1-12 Follows	<input type="radio"/> CH1-16	L	R
	<input type="radio"/> PRE		<input checked="" type="radio"/> MASTER	OVER	OVER
	<input type="radio"/> POST			1	1
MASTER	<input type="radio"/> INPUT	<input checked="" type="checkbox"/> SEL Key Follows Fader Layer		4	4
	<input type="radio"/> PRE	<input checked="" type="checkbox"/> METER Follows SEL Key		8	8
	<input checked="" type="radio"/> POST			12	12
				16	16
				20	20
				24	24
				28	28
				32	32
				36	36
				40	40
				44	44
				48	48

METER   FADER   MASTER M/F   SETUP

## 16 – Options

The DM-24 can be expanded by means of cards (one or two) installed in the expansion slots.

### WARNING

Regarding installation, consult your nearest TASCAM dealer.

Do not install options by yourself which require opening the DM-24 or you will lose your warranty.

You will need a cross-head (Phillips) screwdriver.

- 1 Turn off the DM-24 and disconnect it from the power supply. Disconnect all other equipment connected to it.

### WARNING

The above step is most important. If you do not do this, there is a risk that you may cause damage to the DM-24 as well as other equipment.

- 2 Use the screwdriver to remove the blanking panel from the slot into which you will fit the interface card. Keep the retaining screws in a safe place.

We suggest that you start from the top slot (slot 1) and work downwards. Take care, if you are removing a previously-fitted interface card, that you are removing the retaining screws, and not the smaller screws which fix the card to the rear plate. Also, if you are removing a previously-fitted card, use the

binding posts on the rear plate to help remove the card.

- 3 Remove the interface card from the anti-static protective bag.
- 4 Hold the card by the edges, and insert it, component side upwards, into the slot.
- 5 Locate the card into the connector inside the DM-24. Push the card firmly, without forcing, so that the connector grips the end of the card. A new DM-24 and/or new card may be a little stiff. Make sure that the card is pushed as far as it will go (so that the card rear connector plate touches the rear panel of the DM-24).

The cards available for the DM-24 are:

- Cascade card
- TDIF card
- ADAT card
- AES/EBU card
- Analog I/O card

The setting up of these cards is done using the SLOT screen of the DIGITAL display.

This screen is split into two: the left half of the screen represents the card in slot 1 (the top slot) and the right represents the card in slot 2 (the lower slot). If either or both of these slots are unoccupied, the screen shows No Card for the appropriate slot(s).

## Clock sources

Any cards which provide digital audio input facilities (that is, the cascade card, the TDIF card, the ADAT card and the AES/EBU card), can be used as clock sources.

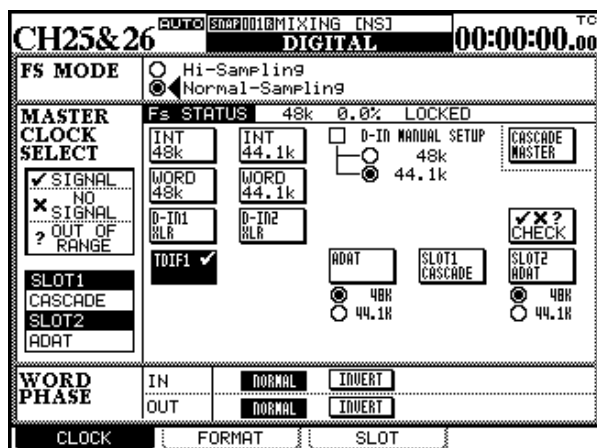

The cards are listed in the CLOCK screen when they are fitted.

In the case of the AES/EBU card, any of the four inputs (two in the case of high sampling frequency) can be selected as the word sync source.

Cascade slaves automatically take their clock from the master (which is free to take it from any other source).

## Cascade card

This card allows the connection of two DM-24 units to increase the number of channels, etc. available. A cascade card must be fitted in slot 1 of each unit to be cascaded.

In a cascade chain, one unit is designated as the *master* unit, and the other as a slave. The *master* unit must always act as the word sync master for the cascade chain (though it can act as a word sync slave in the overall audio system).

There is one connection to be made between the two units. This connection must be made between the cascade cards with the power off on both units. It carries all appropriate audio signals as well as the sync signals and control signals.

Only use a TASCAM cascade cable designed and produced for this purpose when making this connection.

This effectively gives you one double-sized DM-24 mixing console, with the following features:

- 32 mic/line inputs
- 64 channels
- 48 TDIF I/O channels
- 16 lightpipe I/O channels
- 4 AES/EBU 2-channel I/O
- 4 SPDIF 2-channel I/O
- 8 assignable sends and returns
- 4 internal effect processors
- 33 touch-sensitive, motorized faders
- The ability to run a 24-track, 24-bit 96 kHz 5.1 automated mixing environment

## Setting up the cascade

When the connection between the two cascade cards has been made, turn on the slave unit, followed by the master unit. Wait until the fader calibration is ended, and then go to the SLOT screen (soft key 3 in the DIGITAL screens) on the DM-24 which will be used as the **slave**.

The cascade card is identified as CASCADE Card at the top of the slot 1 section of the screen:

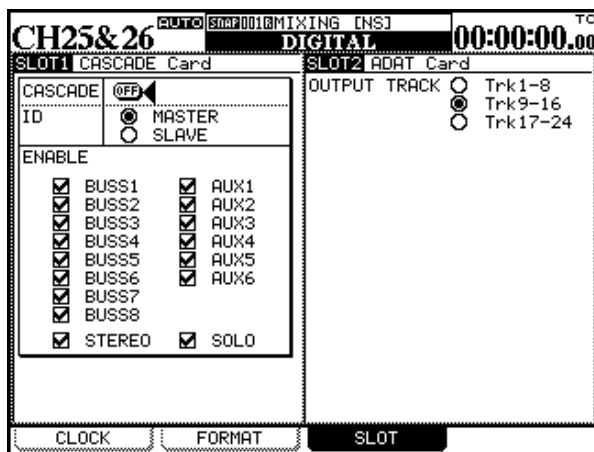

Set the unit up as the cascade slave (SLAVE) using the on-screen radio button.

Now enter the same screen on the unit which will be used as the master, and set that one up as the cascade master (MASTER button).

**On the slave**, set the CASCADE to ON. The display shows Scan Cascade Machine. Leave the cursor by the CASCADE button.

Next, **on the master**, set CASCADE to ON. Leave the cursor by the CASCADE button.

The master display shows Found DM-24 slave machine! and the slave display shows Found DM-24 master machine!.

An error message is displayed if the cascade is established and subsequently becomes disconnected.

## Use of the cascade

Since the cascade card function allows busses, aux sends, etc. to be controlled from the master unit, and thereby be shared between the two cascaded units, the two DM-24s can be used as one large digital console.

The ENABLE checkboxes allow the selection from the master unit of which busses and functions will be shared.

## 16 – Options—Cascade card

Typically, monitoring and stereo outputs should be connected to the cascade master, but there are a number of occasions when these outputs may be used from the slave as well as from the master.

For example:

- Using the stereo buss of both units would allow the stereo buss of one unit to be used dry, with the other unit's stereo buss being processed (compressor, etc.).

- The digital outputs (AES/EBU, SPDIF), together with the balanced analog) allow for up to 6 different stereo mixes to be output simultaneously).
- The monitor outputs on the slave (**CR** and **STUDIO**) could be used to drive a different set of monitor speakers (for example mid-field monitors and smaller computer-type speakers, while the master unit drives main and near-field speakers).

---

### Cascaded facilities

**Soloing and muting** When two units are cascaded, the soloing and muting can be shared. However, note that mute groups and fader groups are not cascaded.

**Snapshots** Snapshot recall and store is cascaded. In other words, naming and storing a snapshot on the master also names and stores it on the slave, and recalling this snapshot on the master also recalls it on the slave.

This data must be dumped and reloaded individually from each unit for further use.

**Automation** When automation is taking place, the master must receive external timecode (either LTC or

MTTC). This timecode is passed through the cascade connection to synchronize the slave automation.

#### NOTE

*The automation UNDO facility is local to one unit only and is not cascaded.*

**MIDI Control Change** Each DM-24 in a cascade can be set to send and receive MIDI Control Change messages which can be used to control DAWs,. Since these can be set independently for each unit in the cascade, a very large number of MIDI controllers can be assigned and used when using two DM-24 units cascaded together.

---

### Cascading and effects

When two units are cascaded, there are four internal effects units in total. These four effects are all available for assignment from any aux send on either unit.

For example, a reverb could be set up on aux 3, a chorus effect on aux 4, a delay on aux 5, and a phased on aux 6, across both units.

#### NOTE

*Only the "local" effects can be used with inserts and assignable inserts on each unit.*

See the separate effects documentation for further details of assigning effects.



**High sampling frequency considerations**

**NOTE**

When cascading, all units must either be in high sampling frequency mode or all units must be in normal sampling frequency mode.

Because of the reduced number of aux sends, the cascade screen changes when the high-frequency mode is selected, as shown here:

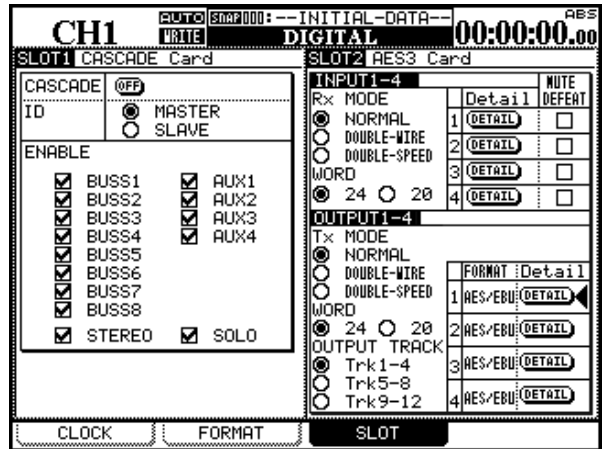

**TDIF-1 card**

The optional TDIF-1 card provides an additional eight channels of I/O (four in high sampling frequency mode).

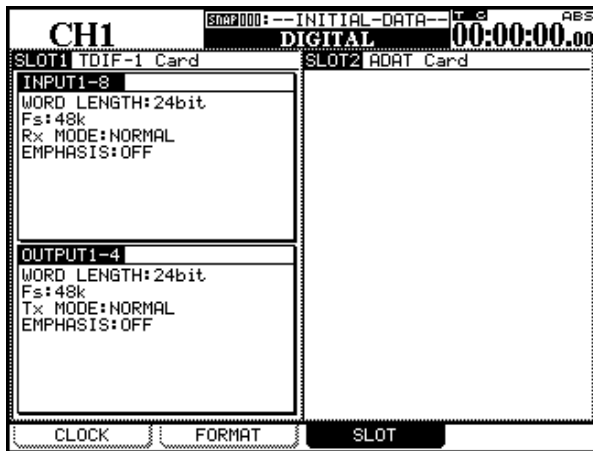

As with the built-in TDIF-1 connectors, data can be accepted using 16, 20 or 24 bit word lengths to match the connected device. The card takes its values for these input parameters from the settings made in the MULTI I/O section of “The FORMAT screen” on page 26.

The output parameters cannot be changed (fixed at 24-bit, with the emphasis status echoing that of the input).

**ADAT card**

The optional ADAT card provides an addition eight channels of digital audio I/O using a “lightpipe” TOSLINK fiber connection.

Any word sync connection from an ADAT connected via this card must be made through the on-board WORD SYNC connector, as the card is not fitted with a word sync input.

The clock can be set as in the same way as for the built-in ADAT connection (“CLOCK settings” on page 24).

All other parameters (word length and sampling frequency) are determined by the ADAT device, and may not be set on this screen.

**NOTE**

This card cannot be used in high sampling frequency mode. A message is displayed in the appropriate part of the screen if the card is fitted and high sampling frequency mode is selected.

## AES3 card

This card allows for the connection of up to four AES input and four output lines.

In normal sampling frequency mode, this provides eight audio channels in each direction, and in high sampling frequency mode, it provides four channels in each direction.

### Input options

The inputs may be selected as return sources for channels (“Assigning inputs to channels” on page 38) and the outputs of the cards may be selected as either buss or aux send destinations (“Output assignments” on page 42).

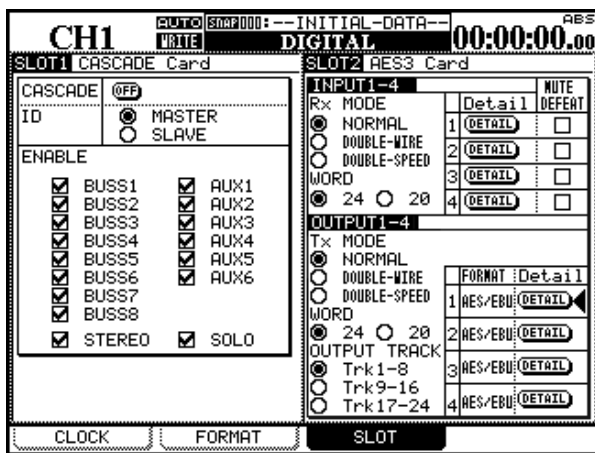

The inputs may be set to be normal sampling frequency (NORMAL), in normal sampling frequency mode. In dual sampling frequency mode, the choices are dual line (DUAL-WIRE) or high speed (HIGH-SPEED)<sup>1</sup>.

1. For definitions, see “Constraints on other devices” on page 112

The word length can be set to be 24 or 20 bits long.

The on-screen DETAIL button provides information on the signal currently being received if the cursor is moved to the button, and **ENTER** is pressed.

This information includes: format, contents of the data, emphasis status, channel mode, sampling frequency word length, etc. Dismiss the popup with the **ENTER** key.

The incoming format is automatically detected.

The MUTE DEFEAT checkbox allows overriding of the automatic mute function. This mute function is usually activated when data is received that does not conform completely to the AES audio standards. However, some units output audio data which is actually correct, but one or two bits in the audio cause it to be interpreted as invalid. If you are using one of these units as an input to the DM-24, you may check these boxes to allow the audio to be input to the DM-24.

#### NOTE

*These checkboxes should only be enabled if you are satisfied that the device from which the data is being received actually is outputting the correct form of audio data.*

### Output options

In high sampling frequency mode, the options for the output format are DUAL-LINE or HIGH-SPEED, as for the input options.

In normal sampling frequency mode, only the NORMAL option is available.

If an attempt is made to select an inappropriate transfer mode, a pop-up error message appears.

Note that unlike the inputs, the format must be selected for all outputs together. It is not possible to make independent settings for each output.

The word length (WORD) can be selected as 24-bit or 20-bit).

Each of the outputs can be selected (normal sampling frequency) to transmit either SPDIF or AES/EBU. In high sampling frequency mode, only AES/EBU is meaningful.

In high-speed mode, only inputs 1 and 3 are used (2 and 4 are unused).

When a DETAIL button is pressed, the details of the audio data currently being output are displayed in a popup button.

Details include: format, contents, emphasis, SCMS status, category, generational status, and sampling frequency. Dismiss the popup with the **ENTER** key.

The NORMAL option is not available for either input or output in this mode.

AES/EBU is the only available output format.

## AD/DA card

This card provides eight balanced channels of analog input and eight balanced channels of analog output, converted at up to 24-bit resolution (the resolution is displayed here, but cannot be changed).

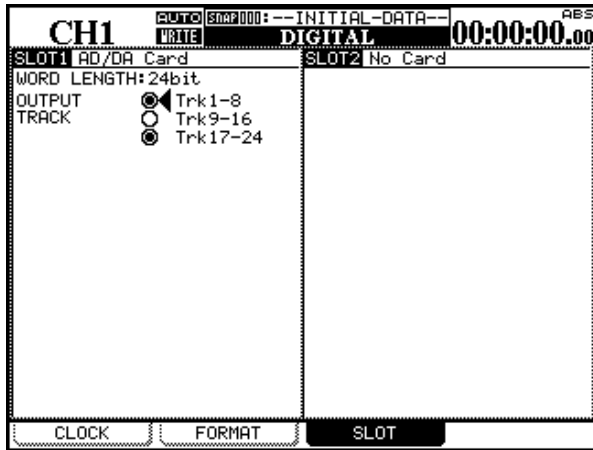

The eight output tracks associated with this card can be selected (1-8, 9-16, 17-24).

Remember that if this card is selected for output from the eight busses, it can be used to drive a surround multi-speaker monitoring system.

## Timecode display

The timecode display shows either the timecode or location point, as selected from the main unit LOCATE DISPLAY MODE option (“SETUP” on page 20).

The **TC** and **LOCATE** indicators light to show the current status of the timecode display, either timecode or location point, respectively.

When the timecode from a connected MTR is locked, the **LOCK** indicator lights.

# 17 – Specifications

This section provides technical information about the DM-24.

---

## Analog audio I/O

---

All specifications are given with the factory reference level of –16dBFS.

<b>MIC</b> inputs (channels 1 through 16)	Balanced XLR-type female connectors <sup>a</sup> Adjustable input level (–56 dBu (TRIM max) to –2dBu (TRIM min)) Input impedance 2.2kΩ
<b>PHANTOM (+48V)</b>	+48V phantom power. Switchable in blocks of 4 channels (1–4, 5–8, 9–12, 13–16)
<b>LINE IN (BAL)</b> inputs (channels 1 through 16)	Balanced 1/4" jacks <sup>b</sup> Adjustable input level (–42dBu (TRIM max) to +12dBu (TRIM min)) Input impedance 10kΩ
<b>INSERT</b> connections (channels 1 through 16)	1/4" TRS jacks <sup>c</sup> Send: nominal output level –2dBu, maximum output level +20dBu, impedance 100Ω Return: nominal input level –2dBu, headroom 16dB, impedance 10kΩ
<b>ASSIGNABLE RETURNS (BAL)</b> (1 through 4)	Balanced 1/4" jacks Nominal input level: –2dBu Headroom: 16dB Input impedance: 5kΩ
<b>ASSIGNABLE SENDS</b> (1 through 4)	Quasi-balanced 1/4" jacks Nominal output level: –2dBu Maximum output level: +14dBu Output impedance: 100Ω
<b>2 TR IN (L/R)</b>	2 x RCA pin jacks Nominal input level –10dBV Headroom: 16dB Input impedance: 10kΩ
<b>STEREO OUTPUT (L/R)</b>	Balanced XLR-type male connectors Nominal output level: +4dBu Maximum output level: +20dBu Output impedance: 100Ω
<b>Stereo INSERT (L/R)</b>	1/4" TRS jacks Send: nominal output level –2dBu, maximum output level +14dBu, impedance 100Ω Return: nominal input level –2dBu, headroom 22dB, impedance 10kΩ
<b>MONITOR OUTPUTS (CR (BAL))</b>	Balanced 1/4" jacks Nominal output level: +4dBu Maximum output level: +20dBu Output impedance: 100Ω
<b>MONITOR OUTPUTS (STUDIO)</b>	RCA pin jacks Nominal output level –10dBV Maximum output level: +6 dBV Output impedance: 100Ω
<b>PHONES</b>	2 x 1/4" stereo jacks 120 mW + 120 mW total <sup>d</sup> 33Ω

- a. all XLR-type connectors are wired 1=ground, 2="hot", 3="cold"
- b. all balanced 1/4" jacks are wired sleeve=ground, ring=cold, tip=hot
- c. all TRS 1/4" jacks are wired sleeve=ground, ring=return, tip=send
- d. Maximum 120mW + 120mW with both **PHONES** jacks driven at maximum

## Digital audio I/O

<b>DIGITAL INPUTS (1, 2)</b>	2 x XLR-type female connectors (input impedance 110Ω) 2 x RCA pin jacks (input impedance 75Ω) AES3-1992 or IEC60958 data format (automatically detected) 24-bit word length Switchable sampling frequency conversion available
<b>DIGITAL OUTPUTS (1, 2)</b>	2 x XLR-type male connectors (output impedance 110Ω) 2 x RCA pin jacks (output impedance 75Ω) AES3-1992 or IEC60958 data format (software selectable) 24-bit word length
<b>TDIF-1(1, 2, 3)</b>	3 x 25-pin D-sub connectors (metric lock screws) Conform to TDIF-1 standard 24-bit word length
<b>ADAT IN/OUT</b>	2 x "Lightpipe" optical connectors Conform to ADAT OPTICAL specifications 24-bit word length
Sampling frequencies	Internal 44.1kHz/48kHz, 88.2kHz/96kHz (high sampling frequencies) External ±6.0%

## Miscellaneous I/O connections

<b>WORD SYNC IN</b>	BNC connector Switchable 75Ω termination TTL level
<b>WORD SYNC OUT/THRU</b>	BNC connector Switchable between through and output TTL level
<b>MIDI IN, OUT, THRU/MTC OUT</b>	3 x 5-pin DIN connectors—conform to MIDI specifications
<b>TIME CODE IN</b>	RCA pin jack Conforms to SMPTE specifications
<b>DTRS REMOTE OUT</b>	15-pin D-sub male (metric lock screws) Conforms to DTRS SYNC standard
<b>EXT SW</b>	1/4" mono jack
<b>TO METER</b>	25-pin D-sub connector (non-metric lock screws) For use with the optional MU-24/DM
<b>RS-422 (for Sony 9-pin)</b>	9-pin female D-sub connector (non-metric lock screws) wired to RS-422 standards
<b>GPI (for Machine start)</b>	9-pin female D-sub connector (non-metric lock screws) wired for GPI control Pin 1=GPI1, Pin 2=GPI2, Pin 3=GPI3, Pin 4=GPI4, Pin 5=GPI5, Pin 6=GPI6, Pin 7=GPI7, Pin 8=GPI8, Pin 9=ground

# 17 – Specifications—Equalization

## Equalization

<b>EQ switch</b>	On/Off	
<b>HIGH filter</b>	Gain:	±18dB, 0.5dB resolution
	Frequency:	31Hz to 19kHz
	Q:	0.27 to 8.65
	Type:	Hi-shelving, Peak, LPF
<b>HI MID filter</b>	Gain:	±18dB, 0.5dB resolution
	Frequency:	31Hz to 19kHz
	Q:	0.27 to 8.65
	Type:	Peak, Notch
<b>LO MID filter</b>	Gain:	±18dB, 0.5dB resolution
	Frequency:	31Hz to 19kHz
	Q:	0.27 to 8.65
	Type:	Peak, Notch
<b>LOW filter</b>	Gain:	±18dB, 0.5dB resolution
	Frequency:	31Hz to 19kHz
	Q:	0.27 to 8.65
	Type:	Low-shelving, Peak, HPF

All filters are fitted with “gain flat” switches

## System performance

THD (nominal level)	20Hz – 20kHz LINE IN to INSERT SEND	< 0.1%
	1 kHz LINE IN to STEREO OUTPUT	< 0.013%
Frequency response (nominal level)	+0.5dB/-1.5dB, MIC/LINE IN to INSERT SEND	20Hz – 25kHz
	+0.5dB/-1.0dB, LINE IN to STEREO OUTPUT	20Hz – 20kHz
	+0.5dB/-1.0dB, LINE IN to BUSS/AUX OUTPUT	20Hz – 20kHz
	+0.5dB/-1.5dB, 2TR IN to MONITOR OUTPUTS	20Hz – 25kHz
Noise level (20Hz – 20kHz, MIC IN to INSERT SEND TRIM:max, 150Ω, -60dB)	MIC IN to INSERT SEND	< -128dBu
	MIC IN to STEREO OUTPUT (BAL)	< -68dBu
	MIC IN to STEREO OUTPUT (UNBAL)	< -74dBu
	MIC IN to BUSS/AUX OUTPUT	< -74dBu
	2TR IN to MONITOR OUTPUT	< -80dBu
Crosstalk @ 1kHz	STEREO/BUSS/AUX OUTPUTS	> 80dB
	MONITOR OUTPUTS	> 70dB

## Physical characteristics

Displays	Backlit 320 x 240 LCD with contrast control 2 x 12-segment LED meters
Faders	17 x 100mm stroke, motor-driven touch-sensitive faders
Maximum overall dimensions (w x d x h) including rest	582 x 657 x 198 (mm) 22.9 x 25.9 x 7.8 (in)
Weight	20.5kg (45.1lbs)
Voltage requirements	120 VAC, 60Hz
	230 VAC, 50Hz
	240 VAC, 50Hz
Power consumption	82W
Peak inrush current	8A
Applicable electromagnetic environment	E4
Supplied accessories	Power cord, warranty card

## Dimensional drawing

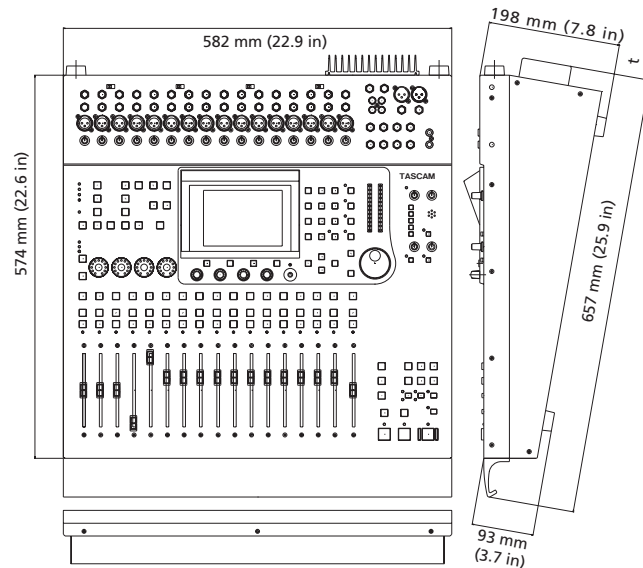

## Messages and troubleshooting

This provides a list of the messages that you may see on the DM-24, which provide information on the operation that you are performing.

Not all of these messages are error messages.

“Information” messages, i.e. those which pop up briefly and provide information about a change in status, etc., are marked with a ●.

“Confirm” messages, where a response may be necessary (usually confirm with the **ENTER** key or cancel with the cursor keys) are marked with a ✓.

Error messages demanding action other than a simple confirmation are shown with a ✘, but even these do not necessarily indicate an error.

Action	Message	Explanation
✓	Flash Write Count EQ Library: aaaa Gate/Expand Library: bbbb Comp Library: cccc Effect Library: ddddd Snapshot Area 1: eeee Area 2: ffff Area 3: gggg Area 4: Press ENTER to continue.	The message displayed when the library flash memory usage is checked. The “aaaa” etc. values are replaced by real numbers (“FLASH Info.” on page 22).
✓	Copy OK? Press ENTER to confirm, or a cursor key to cancel.	Shown when about to copy parameters in the UTILITY PARAM. COPY screen (“UTILITY copying” on page 62).
✘	Reboot after System Data All has been loaded. Press ENTER to confirm, or a cursor key to cancel.	Shown after ALL System Data has been received (“Bulk transfer of data to the DM-24” on page 96). The DM-24 should be rebooted. Turn down the volume of all other devices and press ENTER.
✘	Can't load data. Unexpected data type. Load data type: [DM-24 SNAPSHOT SNGL] Press ENTER to continue.	Shown if the data type being loaded by MIDI Bulk Dump transfer does not match the expected type (“Bulk transfer of data to the DM-24” on page 96).

## 17 – Specifications—Messages and troubleshooting

Action	Message	Explanation
✘	95% of automation memory has been used. Please back up automation data now. Press ENTER to continue.	Shown if the automation memory area is too full for future use. Back up unwanted automation banks using MIDI Bulk Dump ("Bulk transfer of data from the DM-24" on page 95), and delete them.
●	Already assigned.	Shown when an attempt is made to add a device already in the Machine Control List to the list.
✓	Assignable send/return 1 is INSERT MODE Press ENTER to continue.	An attempt has been made to assign a channel input from an assignable return which is currently assigned as an insert loop ("Assignable sends" on page 37).
✓	Automation Bank Memory is full. Check the Bank memory. Press ENTER to continue.	Shown if the automation memory area is full. Back up unwanted automation banks using MIDI Bulk Dump ("Bulk transfer of data from the DM-24" on page 95), and delete them.
✓	Automation Bank01 Recalled.	Shown after recalling an automation memory bank.
●	AUTOMATION Screen [Page: CONFIG Setup] Individual module setup... Individual parameter setup...	Shown when automation mode setup is turned off
✓	Aux1-2 to STEREO is assigned. Press ENTER to continue.	In the master buss assignment, this warning appears if an attempt is made to override an existing assignment ("AUX 1-2" on page 40).
●	Can't recall snapshot99. Different Fs mode.	An attempt has been made to recall a snapshot which was stored in a different sampling frequency mode from the current mode ("Library functions" on page 99).
✓	Can't Select Normal Different Fs mode Press ENTER key to continue.	An attempt has been made to select the normal transmission in high sampling frequency mode (must be "dual-line" or "high-speed")—"High sampling frequency" on page 112.
✓	Can't select Normal Different Fs mode Press ENTER to continue.	An attempt is made to select the normal format in high sampling frequency mode ("High sampling frequency" on page 112).
●	Can't store from Master Module. There are no EQ parameters.	An attempt has been made to store an EQ library entry from a master module (which cannot accept these parameters) ("Library functions" on page 99).
●	Can't recall to Stereo Module. Comp is not inserted.	An attempt has been made to load compressor settings from the library to a master module where a compressor has not been inserted ("Library functions" on page 99).
●	Can't store from Stereo Module. Comp is not inserted.	An attempt has been made to store compressor settings to the library from a master module where a compressor has not been inserted ("Library functions" on page 99).
●	Can't store from Chxx GATE/EXP is not inserted.	An attempt has been made to store gate/expander settings to the library from a module where a gate or expander has not been inserted ("Library functions" on page 99).
✓	Can't use RS-422 port. Serial Out: MTC OUT Setup with MIDI/MC[SETUP] Press ENTER to continue.	The serial port has already been assigned to use MIDI Timecode, and therefore cannot be used for control ("Serial output" on page 84).
✘	Can't Load MIDI Sys Ex data. SysEx filter is set in MIDI/MC [SETUP] screen] Press ENTER to continue.	Shown if a MIDI filter has been set up preventing MIDI System Exclusive reception ("MIDI filtering" on page 84) and an attempt is made to load data.
●	Can't recall Master Module. There are no EQ parameters.	An attempt has been made to recall an EQ library entry to a master module (which cannot accept these parameters) ("Library functions" on page 99).



## 17 – Specifications—Messages and troubleshooting

Action	Message	Explanation
✘	Can't do MIDI Bulk Load with timecode running	Shown if an attempt is made to load Bulk Data with timecode running ("Bulk transfer of data to the DM-24" on page 96)
✓	Can't assign fader grouping layer.	Shown when an invalid fader grouping is attempted ("Grouping layers" on page 71).
✓	Can't assign mute grouping layer.	Shown when an invalid mute grouping is attempted ("Grouping layers" on page 71).
✓	Can't Dump MIDI Sys Ex data. SysEx filter is set in MIDI/MC [SETUP] screen] Press ENTER to continue.	Shown if a MIDI filter has been set up preventing MIDI System Exclusive transmission ("MIDI filtering" on page 84) and an attempt is made to dump data.
●	Can't Recall COMP Libraryxxx.	The compressor library entry xxx cannot be recalled as it does not exist (no data has been written to that library entry) — "Library functions" on page 99
●	Can't Recall Effect U1-xxx.	The user effect 1 library entry xxx cannot be recalled as it does not exist (no data has been written to that library entry) — "Library functions" on page 99
●	Can't Recall EQ Libraryxxx	The EQ library entry xxx cannot be recalled as it does not exist (no data has been written to that library entry)—"Library functions" on page 99
●	Can't recall GATE/EXP Libraryxxx.	The gate/expander library entry xxx cannot be recalled as it does not exist (no data has been written to that library entry ("Library functions" on page 99)
●	Can't recall Snapshotxxx.	The snapshot xxx cannot be recalled as it does not exist (no data has been written to that library entry)
●	Can't recall to Chxx. GATE/EXP is not inserted.	An attempt has been made to load gate/expander settings from the library to a module where a gate or expander has not been inserted ("Library functions" on page 99).
✓	Can't select dual-line Different Fs mode Press ENTER key to continue.	An attempt has been made to select dual-line transmission in normal sampling frequency mode (must be "normal")— "High sampling frequency" on page 112.
✓	Can't select dual-line Different Fs mode Press ENTER to continue.	An attempt is made to select the dual-line format in normal sampling frequency mode ("High sampling frequency" on page 112).
●	Can't STORE Automation Bank01.	Shown if there is a problem overwriting a protected memory bank (automation)
✘	Cascade connection broken! Press ENTER to continue.	Shown on cascade master when an existing cascade connection has become disconnected or is otherwise inoperative ("Cascade card" on page 119).
✓	Ch parameters Setup? Press ENTER to confirm, or a cursor key to cancel.	Shown when a global screen has been used to make changes to a range of channels at one time (for instance aux sends, digital delay, etc.), ("Module operations" on page 49.)
●	CH x is already inserted.	An attempt has been made to assign a second insert loop to a channel which has already had an insert loop assigned to it ("Assignable returns" on page 36).
✓	Clear all fader grouping layers ? Press ENTER to confirm, or a cursor key to cancel.	Shown when the on-screen CLEAR button has been pressed to clear all fader groups ("Grouping layers" on page 71).
✓	Clear all muting grouping layers ? Press ENTER to confirm, or a cursor key to cancel.	Shown when the on-screen CLEAR button has been pressed to clear all mute groups ("Grouping" on page 69).
✓	Clear Current Automation Event Data? Press ENTER to confirm, or a cursor key to cancel.	Shown in automation, when the current data is to be cleared (using soft key 2)

## 17 – Specifications—Messages and troubleshooting

Action	Message	Explanation
✓	Clear all current automation data? Press ENTER to confirm, or a cursor key to cancel.	Shown when attempting to clear all current automation memory.
✓	Clear this fader grouping? Press ENTER to confirm, or a cursor key to cancel.	Shown when the SEL key of a group master is pressed. Pressing ENTER will clear the group (“Grouping” on page 69).
✓	Clear this fader grouping? Press ENTER to confirm, or a cursor key to cancel.	Shown when an assigned fader grouping master group’s SEL key is pressed (“Grouping layers” on page 71). ENTER will clear the group.
✓	Clear this mute grouping? Press ENTER to confirm, or a cursor key to cancel.	Shown when the SEL key of a group master is pressed. Pressing ENTER will clear the group (“Grouping” on page 69).
✓	Clear this mute grouping? Press ENTER to confirm, or a cursor key to cancel.	Shown when an assigned mute grouping master group’s SEL key is pressed (“Grouping layers” on page 71). ENTER will clear the group
✓	Clock check Results Current Fs: 48kHz Sources Word : 44.1kHz 0.0% Digi In 1 : Out of Range Digi In 2 : Unuseable TDIF1 : 44.1kHz 0.0% TDIF2 : 44.1kHz 0.0% TDIF3 : Unuseable Slot1 : 48kHz + 1.0% Slot2 : Unuseable Press ENTER to continue.	A sample popup shown when a clock check is performed (“CLOCK settings” on page 24).
●	COMP Libraryxxx Recalled to CHy.	The compressor library entry xxx has been successfully recalled, and the settings applied to channel y — “Library functions” on page 99
●	COMP Libraryxxx is Read Only!	An attempt is being made to overwrite a read-only compressor library entry (“Library functions” on page 99).
✓	Confirm LIST Auto Detect? Press ENTER to confirm, or a cursor key to cancel.	Shown when the on-screen LIST AUTO DETECT button is pressed (“Auto-detection of devices” on page 81).
✓	Confirm TRA Auto Detect? Press ENTER to confirm, or a cursor key to cancel.	Shown when the on-screen button is pressed to start an automatic search for transport control devices (“Auto-detection of devices” on page 81).
✓	Copy Ch Fader level->Aux level? Press ENTER to confirm, or a cursor key to cancel.	From the global aux screens, the channel fader levels are being copied to the specified aux level (“Aux sends (global)” on page 55).
●	Copy from Ch2 Automation config.	Shown in automation setup parameter copy operations
✗	Data Load Error. (sequence or checksum) MIDI Bulk Load canceled. Press ENTER to continue.	Shown if the Bulk Data sent to the DM-24 is corrupt or cannot otherwise be received successfully (“Bulk transfer of data to the DM-24” on page 96).
✓	Delete Automation Bank01? Press ENTER to confirm, or a cursor key to cancel.	Shown when requesting the deletion of an automation memory bank.
✗	Device is not active.	Shown if a device has been selected in the Machine Control List (“Selecting devices for control” on page 80), but is not switched on or connected or is otherwise unavailable.

## 17 – Specifications—Messages and troubleshooting

Action	Message	Explanation
✘	Digital input X: Fs convert On Can't select Master Clock. Press ENTER to continue.	An attempt has been made to use a digital input as a word sync clock source, but the sampling frequency conversion is turned on, preventing this input from being used as a clock source ("CLOCK settings" on page 24).
✓	DIGITAL INPUT1 (XLR) set to master clock Press ENTER to continue.	Warning message sent when Digital input is set as master clock and then unassigned.
✘	Digital INx is not audio data. Press ENTER to continue.	The data received at digital input x is not being read as valid audio data by the DM-24. Check the source ("CLOCK settings" on page 24).
●	Effect P1-000 is Read Only!	An attempt is being made to overwrite a read-only effector library entry ("Library functions" on page 99).
●	Effect P1-xxx Recalled.	The preset library entry xxx for effect 1 has been successfully recalled ("Library functions" on page 99)
●	EQ Libraryxxx is Read Only!	An attempt is being made to overwrite a read-only EQ library entry ("Library functions" on page 99).
●	EQ Libraryxxx Recalled to CHy	The EQ library entry xxx has been successfully recalled, and the settings applied to channel y ("Library functions" on page 99)
✓	External Control List Full. Press ENTER to continue.	Shown when the external control list is full (limit of eight devices). See "External control" on page 87
✘	Flash Memory [Snapshot Area 0] has been written 99950 times. Please contact TASCAM service. Press ENTER to continue.	The flash memory specified here has been used the number of times specified. Although you can continue to use the unit safely for some time to come, we recommend that you consult your TASCAM service center for advice ("FLASH Info." on page 22).
✓	Flash Write Count Automation Area 1: aaaa Area 2: bbbb Area 3: cccc Area 4: dddd Area 5: eeee Area 6: ffff Area 7: gggg Area 8: hhhh Press ENTER to continue.	The message displayed when the automation flash memory usage is checked. The "aaaa" etc. values are replaced by real numbers ("FLASH Info." on page 22).
✓	Found cascade slave Press ENTER to confirm, or a cursor key to cancel.	Popup message shown when cascade slave unit exists ("Cascade card" on page 119).
●	GATE/EXP Libraryxxx Recalled to CHy.	The gate/expander library entry xxx has been successfully recalled, and the settings applied to channel y ("Library functions" on page 99)
●	GATE/EXP Libraryxxx is Read Only!	An attempt is being made to overwrite a read-only gate/expander library entry ("Library functions" on page 99).
✓	Group x is empty.	An attempt has been made to assign an empty group (x) to a grouping layer ("Grouping layers" on page 71).
✓	Grouping link(Fader→Mute) Press ENTER to confirm, or a cursor key to cancel.	Shown when the on-screen LINK button has been pressed to link mute and fader groups ("Grouping" on page 69).
✓	Grouping link(Mute→Fader) Press ENTER to confirm, or a cursor key to cancel.	Shown when the on-screen LINK button has been pressed to link mute and fader groups ("Grouping" on page 69).
✘	Hi-sampling mode not supported. Press ENTER to continue.	The high sampling frequency mode is not supported (by another device in the system of which the DM-24 is aware). Reset the DM-24 to normal sampling frequency mode.

## 17 – Specifications—Messages and troubleshooting

Action	Message	Explanation
●	LOCATE TIME 0 00 : 00 : 00.00 ABS	The popup that appears when a location memory is selected (“Location memories” on page 85).
✓	Machine Control List Full Press ENTER to continue.	No more than 16 devices can be input in the Machine Control List (“Selecting devices for control” on page 80).
✗	Master clock has gone out of range. Console muted. Press ENTER to continue.	The master clock frequency has gone outside permissible limits or is not present ( $\pm 6.0\%$ of the nominal frequency). The DM-24 output is muted (“CLOCK settings” on page 24).
✓	MC Transport Maps 0 : DA98 ID=01 1 : DA88 ID=02 2 : DA38 ID=03 3 : MMC Open ID=120 4 : MTC Generate 5 : ADAT ID=01 6 : None 7 : None 8 : None 9 : None Press ENTER to continue.	A sample transport map popup (“Viewing the transport mappings” on page 83).
✗	MIDI Active Sensing has been disconnected Press ENTER to continue.	Active Sensing has been turned on (“MIDI OUT Active Sensing” on page 84), and the remote device is now disconnected.
✓	MIDI BULK Dump in progress_ Done!	Shown after a MIDI Bulk Dump has been successfully completed (“Bulk transfer of data from the DM-24” on page 95).
✓	MIDI BULK Dump in progress _ Press a cursor key to cancel.	A MIDI Bulk Dump is taking place, and can be cancelled with a cursor key (“Bulk transfer of data from the DM-24” on page 95)
✓	MIDI Bulk Load in progress_ [DM-24 SNAPSHOT ALL] Press a cursor key to cancel.	Shown when Bulk data is being transferred to the DM-24 (“Bulk transfer of data to the DM-24” on page 96). The type of data is shown on the second line.
✓	MIDI Bulk Load Ready _ Press a cursor key to cancel.	Shown when about to start a bulk load (“Bulk transfer of data to the DM-24” on page 96).
✓	MIDI Bulk Load completed _ Press a cursor key to cancel.	Shown when MIDI Bulk data has been received successfully by the DM-24 (“Bulk transfer of data to the DM-24” on page 96).
✓	MIDI Ch1 [control No.1] is already assigned. Press ENTER to continue.	Shown if a conflict occurs in assigning channels and controls (“Control Change messages to and from the DM-24” on page 96).
✓	MIDI Ch1 is already assigned. Press ENTER to continue.	Shown when a MIDI channel has already been assigned for Program Change, etc. (“Program Change channels” on page 83)
✗	MIDI System Reset Received, Reboot Mixer? Press ENTER to confirm, or a cursor key to cancel.	A Reset Message has been received (“RESET (ffh)” on page 84) from a remote MIDI device.
✓	Mixer will mute while checking OK to continue? Press ENTER to confirm, or a cursor key to cancel.	While the DM-24 is changing between normal and high sampling frequency modes, it will mute. This is shown just before the mute operation (“High sampling frequency” on page 25).
✓	No card in SLOT1. Press ENTER to confirm, or a cursor key to cancel.	An attempt is made to assign a return from a non-existent slot card (“Card slots” on page 36).
✓	No cascade slave Press ENTER to continue.	Popup message shown when cascade slave unit cannot be located (“Cascade card” on page 119).

## 17 – Specifications—Messages and troubleshooting

Action	Message	Explanation
✓	OK to overwrite Automation Bank01? Press ENTER to confirm, or a cursor key to cancel.	Shown when requesting the storage of automation data to a bank already containing data.
✓	OK to Overwrite COMP Library024 from CH2? Press ENTER to confirm, or a cursor key to cancel.	Data already exists in compressor library entry xxx as an attempt is made to store the EQ data from channel y (“Library functions” on page 99).
✓	OK to Overwrite Effect U1-xxx? Press ENTER to confirm, or a cursor key to cancel.	Data already exists in user effect 1 library entry xxx as an attempt is made to store the current effector data (“Library functions” on page 99).
✓	OK to Overwrite EQ Libraryxxx from CHy? Press ENTER to confirm, or a cursor key to cancel.	Data already exists in EQ library entry xxx as an attempt is made to store the EQ data from channel y (“Library functions” on page 99.).
✓	OK to Overwrite GATE/EXPAND Libraryxxx from CHy? Press ENTER to confirm, or a cursor key to cancel.	Data already exists in gate/expander library entry xxx as an attempt is made to store the EQ data from channel y (“Library functions” on page 99).
✓	OK to Overwrite Snapshot? Press ENTER to confirm, or a cursor key to cancel.	Data already exists in the snapshot library entry to which an attempt is being made to store the data (“Library functions” on page 99).
✓	OK to overwrite Transport Map? Press ENTER to confirm, or a cursor key to cancel.	Shown when the transport control mapping is to be overwritten (“Machine Control mapping memories” on page 82).
✓	OK to assign STEREO to Aux1-2? Press ENTER to confirm. or a cursor key to cancel.	Shown when assigning a link of stereo to Aux 1-2 to overwrite a setting of Aux 1-2 to Stereo (“AUX 1-2” on page 40) (“Library functions” on page 99).
✓	OK to assign Aux1-2 to STEREO Press ENTER to confirm, or a cursor key to cancel.	Shown when assigning a link of Aux 1-2 to stereo to overwrite a setting of Stereo to Aux 1-2 link (“AUX 1-2” on page 40).
●	Panel keys [REHEARSE/WRITE/TRIM]	Shown in automation mode setup
✓	Paste Buffer data to Ch2? Press ENTER to confirm, or a cursor key to cancel.	Shown when pasting automation setup parameter data to another channel.
●	Paste Ch2 Automation config.	Shown in automation setup parameter copy operations
✓	Re-assign fader (cut) group? Press ENTER to confirm, or a cursor key to cancel.	Shown when a fader group is to be reassigned (“Grouping” on page 69).
✓	Re-assign fader grouping? Press ENTER to confirm, or a cursor key to cancel.	Shown when changing a group slave to be the master of another group (“Grouping layers” on page 71).
✓	Re-assign fader grouping layer? Press ENTER to confirm, or a cursor key to cancel.	Shown when re-assigning an assigned group to another grouping layer (“Grouping layers” on page 71).
✓	Re-assign mute grouping layer? Press ENTER to confirm, or a cursor key to cancel.	Shown when re-assigning an assigned group to another grouping layer (“Grouping layers” on page 71).
✓	Re-assign mute grouping? Press ENTER to confirm, or a cursor key to cancel.	Shown when changing a group slave to be the master of another group (“Grouping layers” on page 71).
✓	Re-assign mute group? Press ENTER to confirm, or a cursor key to cancel.	Shown when a mute group is to be reassigned (“Grouping” on page 69).

## 17 – Specifications—Messages and troubleshooting

Action	Message	Explanation
✓	Recall Automation Bank01? Current data will be erased. Press ENTER to confirm, or a cursor key to cancel.	Shown when requesting the recall of an automation memory bank.
✓	Return x is input into Chyy Press ENTER to continue.	An attempt has been made to assign a return to a channel, when it has already been assigned to a channel (“Assignable sends” on page 37).
●	Scanning for cascade slave...	Displayed by cascade master when scanning for slave (“Cascade card” on page 119).
✓	Signal Info: ADAT ADAT clock: Internal Press ENTER to continue.	Sample popup clock information screen for ADAT device (“CLOCK settings” on page 24).
✓	Signal Info: Digital in1 Format: AES/EBU Contents: Audio Emphasis: No enable Channel Mode: Two channel Fs: 44.1kHz Word Length: 24bit Press ENTER to continue.	Sample information popup about the Digital input data (“CLOCK settings” on page 24).
✓	Signal Info: Digital in1 Format: AES/EBU Contents: Audio Emphasis: None Channel Mode: Two channel Fs: 44.1kHz Word Length: 24bit Press ENTER to continue.	Sample popup information screen for AES/EBU data received at a DIGITAL IN (“CLOCK settings” on page 24).
✓	Signal Info: Digital in1 Format: SPDIF Contents: Audio Emphasis: None SCMS: on Category: Mixer Generation: Home Copy Fs: 44.1kHz Word Length: 20bit  Press ENTER to continue.	Sample popup information screen for SPDIF data received at a DIGITAL IN (“CLOCK settings” on page 24).
✓	Signal Info: Digital out 1 Format: SPDIF Contents: Audio Emphasis: None SCMS: off Category: General Fs: 44.1kHz Word Length: 24bit Press ENTER to continue.	Sample information about the data transmitted from a digital output (“CLOCK settings” on page 24).
✓	Signal Info: Digital out 1 Format: SPDIF Contents: Audio Emphasis: None SCMS: off Category: General Fs: 44.1kHz Word Length: 24bit Press ENTER to continue.	Sample popup information screen for SPDIF data transmitted from a DIGITAL OUT (“CLOCK settings” on page 24).

## 17 – Specifications—Messages and troubleshooting

Action	Message	Explanation
✓	Signal Info: Digital out1 Format: AES/EBU Contents: Audio Emphasis: None Channel Mode: Two channel Fs: 44.1kHz Word Length: 24bit Press ENTER to continue.	Sample popup information screen for AES/EBU data transmitted from a DIGITAL OUT (“CLOCK settings” on page 24).
✓	Signal Info: INTERNAL Fs: xxxkHz Press ENTER to confirm, or a cursor key to cancel.	The information screen given when the master clock is selected (“CLOCK settings” on page 24).
✓	Signal Info: Slot1 AES3 Card input 1 Format: AES/EBU Contents: Audio Emphasis: None Channel Mode: Two Channel Fs: 44.1kHz Word Length: 24bit Press ENTER to continue.	Sample popup information for optional AES slot card input (“CLOCK settings” on page 24).
✓	Signal Info: Slot1 AES3 Card Output1 Format: SPDIF Contents: Audio Emphasis: None SCMS: off Category: General Fs: 44.1kHz Word Length: 24bit Press ENTER to continue.	Sample popup information for optional AES slot card output (“CLOCK settings” on page 24).
✓	Signal Info: Slot1 Option: AES3 Card Press ENTER to continue	Sample popup clock information screen for device connected to optional AES3 slot card (“CLOCK settings” on page 24).
✓	Signal Info: TDIF1 Input Tx/Rx mode: Dual-line Fs: 192kHz Word Length: 24bit Emphasis: None Output Tx/Rx mode: Normal Fs: 44.1kHz Word Length: 24bit Emphasis: No Press ENTER to continue.	Sample popup information screen for TDIF audio data received by and transmitted from a TDIF connector (“CLOCK settings” on page 24).
✓	Signal Info: TDIF1 Input Tx/Rx mode: Dual-line Fs: 192kHz Word Length: 24bit Emphasis: None Output Tx/Rx mode: Normal Fs: 4401kHz Word Length: 24bit Emphasis: No Press ENTER to continue.	Sample popup information (details of a TDIF connection)—“CLOCK settings” on page 24.
✓	Signal Info: WORD No signal Press ENTER to continue.	The screen given when the clock signal from the source selected is not present (“CLOCK settings” on page 24).

## 17 – Specifications—Messages and troubleshooting

Action	Message	Explanation
✓	Signal Info: Word New clock source is out of range, Master clock is unchanged. Press ENTER to continue.	An attempt has been made to select a new clock source, which is out of range (“CLOCK settings” on page 24).
✗	SLOT1 Card is Unknown Check Card Type Press ENTER key to continue.	The DM-24 cannot recognize the card fitted in the optional slot. Check the card and its installation in the DM-24. Contact your TASCAM dealer for assistance if necessary.
●	Snapshot000 is Read Only!	An attempt is being made to overwrite a read-only snapshot library entry (“Library functions” on page 99).
●	Snapshotxxx Recalled.	Snapshot xxx has been successfully recalled from the library (“Library functions” on page 99).
✗	Source Fs unlocked. Press ENTER to continue.	The sampling frequency of the clock source is no longer valid. Reconnect if necessary, and recheck the source (“CLOCK settings” on page 24).
✓	ST L NK ON(CH EVEN→ODD) Press ENTER to confirm, or a cursor key to cancel.	Shown when the SEL keys are used to link two channels (“Linking and unlinking modules” on page 60).
✓	ST L NK ON(CH ODD→EVEN) Press ENTER to confirm, or a cursor key to cancel.	Shown when the SEL keys are used to link two channels (“Linking and unlinking modules” on page 60).
✓	ST LINK ON(CH xx→yy) and Re-assign fader (cut) grouping? Press ENTER to confirm, or a cursor key to cancel.	Shown when SEL keys are used to link two channels and the stereo link will cause a current group assignment to change (“Linking and unlinking modules” on page 60).
✓	ST L NK OFF(CH ODD→EVEN) Press ENTER to confirm, or a cursor key to cancel.	Shown when SEL keys are used to break a channel link. (“Linking and unlinking modules” on page 60).
●	STEREO L-R is already inserted.	An attempt has been made to assign a second insert loop to the stereo buss when an insert loop has already been assigned to it (“Master settings” on page 40).
✓	STEREO to Aux1-2 is assigned. Press ENTER to continue.	In the master buss assignment, this warning appears if an attempt is made to override an existing assignment (“AUX 1-2” on page 40).
●	Store to Automation Bank01.	Shown when storing automation data.
●	Stored to COMP Libraryxxx from CHy.	The compressor settings from channel y are now stored in EQ library entry xxx (“Library functions” on page 99).
●	Stored to Effect Libraryxxx.	The effector settings are now stored in library entry xxx (“Library functions” on page 99).
●	Stored to EQ Libraryxxx from CHy.	The EQ settings from channel y are now stored in EQ library entry xxx (“Library functions” on page 99).
●	Stored to GATE/EXPAND Libraryxxx from CHy.	The gate/expander settings from channel y are now stored in EQ library entry xxx (“Library functions” on page 99).
●	Stored to Snapshotxxx.	The snapshot settings have been successfully stored to snapshot library entry xxx (“Library functions” on page 99).
✓	SYSTEM update Ready _ Press a cursor key to cancel.	The system software is ready to be upgraded. Cancel the operation by pressing any of the cursor keys.
●	There is no current data.	Shown as a warning that there is no current data to be manipulated (automation)



## 17 – Specifications—Messages and troubleshooting

Action	Message	Explanation
✓	There are no copy parameters Press ENTER to continue.	Shown when an attempt is made to copy parameters in the UTILITY PARAM. COPY screen (“UTILITY copying” on page 62) but no parameters have been set.
✓	Unmatched Fs. Do not show this message in the future? Press ENTER to confirm, or a cursor key to cancel.	Shown when the stored sampling frequency does not match the current sampling frequency (automation data recall)
✓	Unmatched timecode. Do not show this message in the future? Press ENTER to confirm, or a cursor key to cancel.	Shown when the stored timecode type does not match the current timecode type (automation data recall)
✓	Version information. Console Main : 1.00 Panel : 1.00 Remote : 1.00 Download: 1.00 Effector: TC Works: 1.00 Antares : 1.00 TASCAM: 1.00 Press ENTER to continue.	Popup shown when version number request is made (“Version Info.” on page 22).

# 17 – Specifications—Block diagram (normal sampling frequency)

## Block diagram (normal sampling frequency)

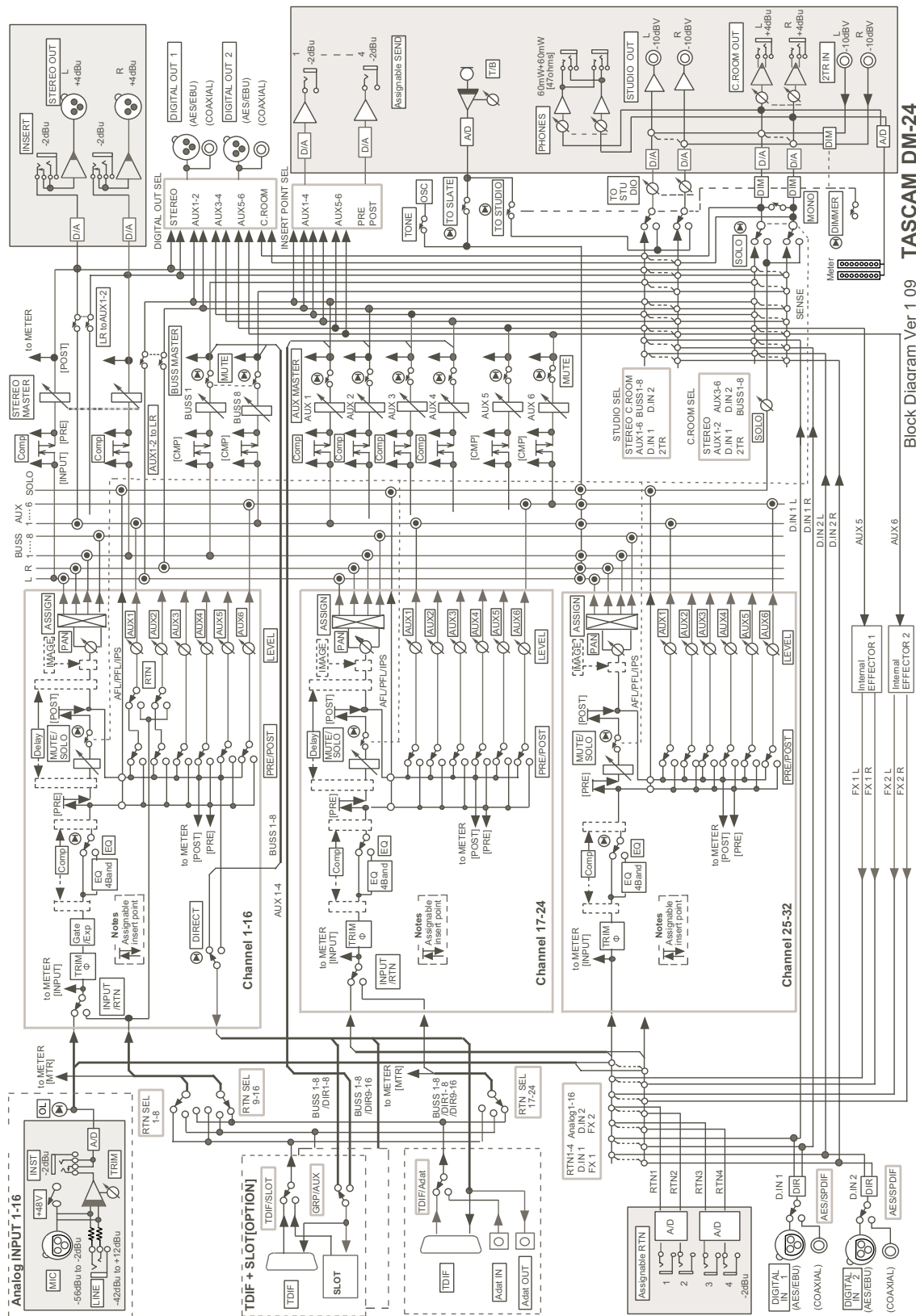

Block Diagram Ver 1 09 TASCAM DM-24

# 17 – Specifications—Block diagram (high sampling frequency)

## Block diagram (high sampling frequency)

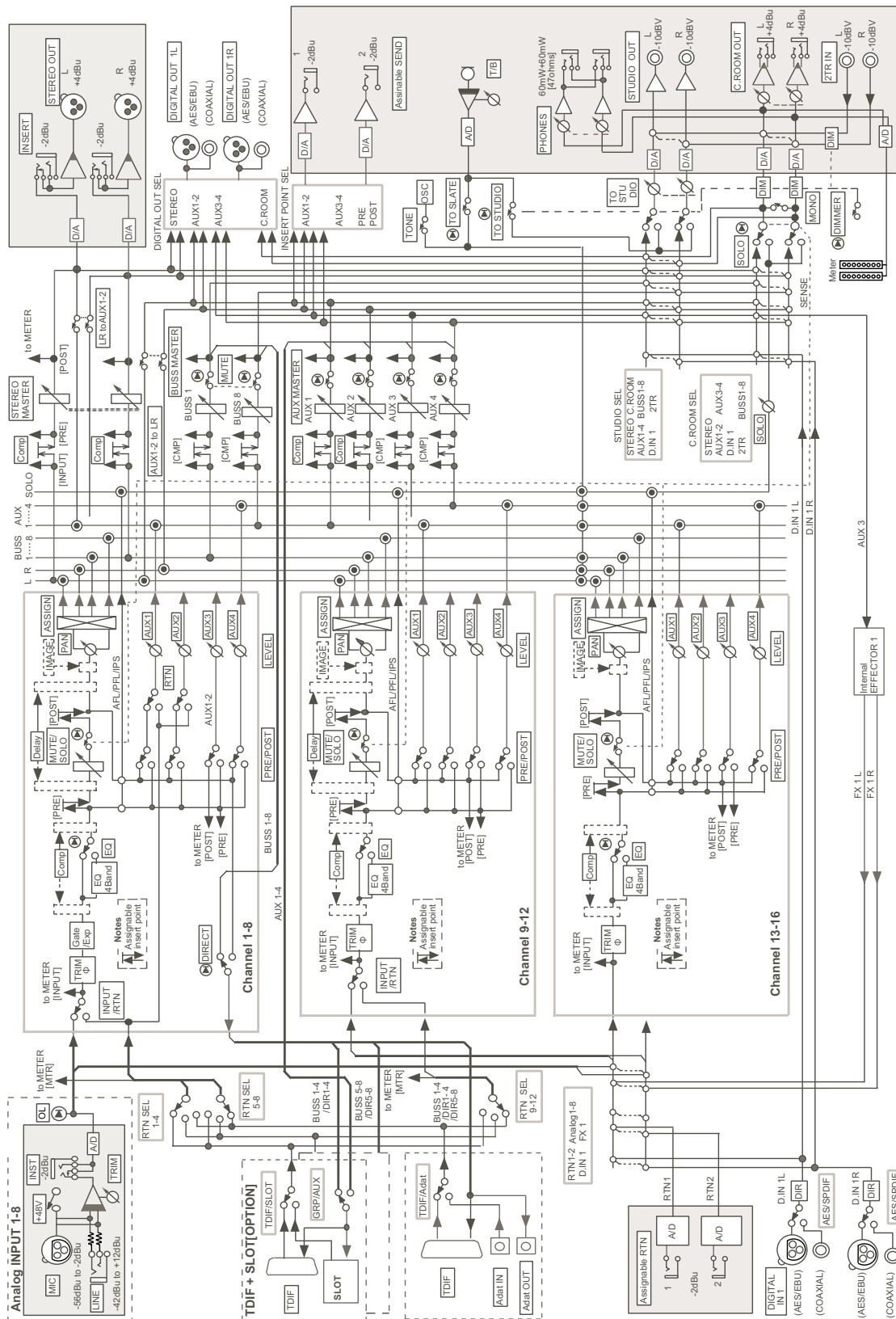

Block Diagram Ver 1.09 TASCAM DM-24 HS

# 17 – Specifications—Level diagram

## Level diagram

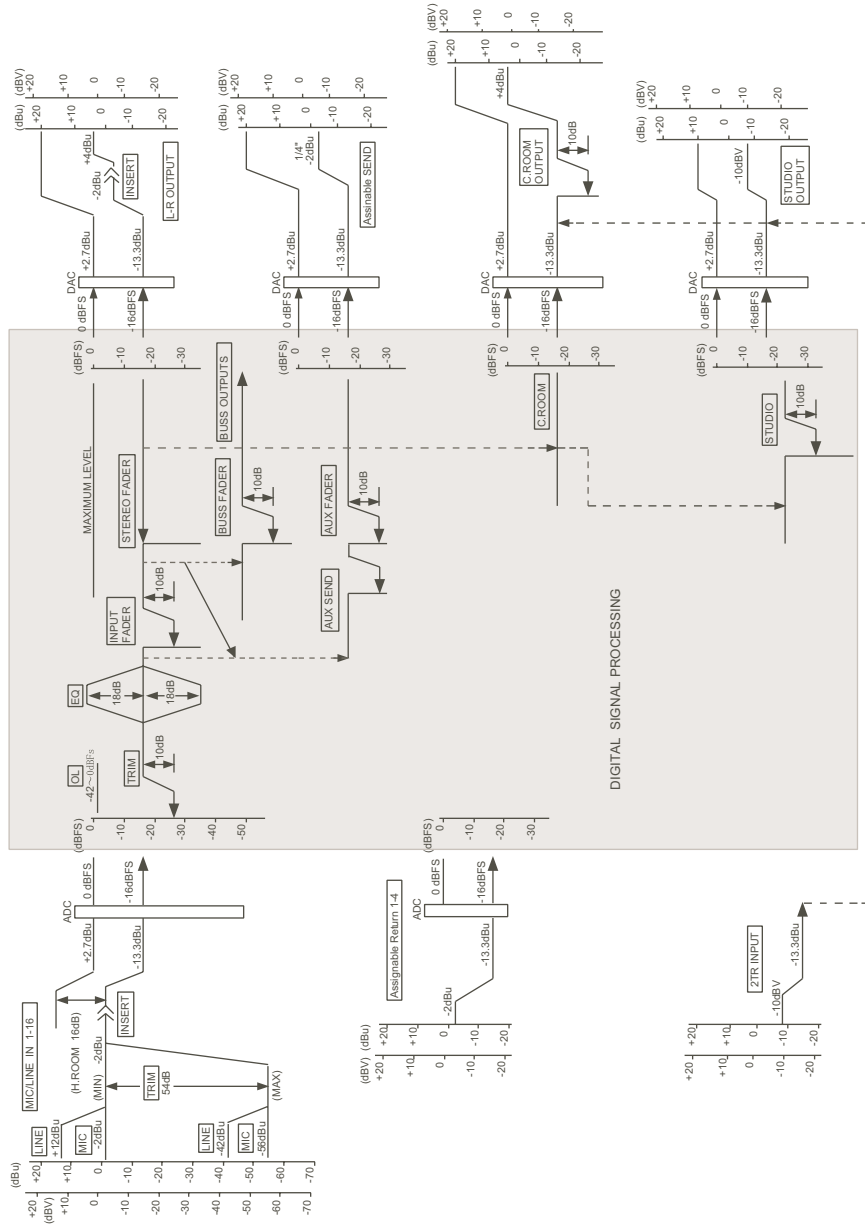

**TASCAM DM-24**  
Level Diagram Ver 1.07

**A**

accelerating the PODs *13*  
 AD/DA card *123*  
 ADAT *25, 34, 34, 36, 37, 42, 47, 118, 121*  
 ADAT connections *25, 36–37, 47, 121*  
 AES/EBU *26, 35, 39, 47, 112, 113, 118, 122*  
     as word sync source *25*  
 AES3 card *25, 122*  
 AFL *23, 75, 75*  
 ALL INPUT and AUTO MON *87*  
 ALL INPUT key *33*  
 ALL SAFE key *33, 82*  
 analog connections *44*  
 analog input levels *21, 29*  
 analog inputs *29, 29, 113, 123, 124*  
 analog monitoring *45*  
 analog outputs *29, 123, 124*  
 analog performance *126*  
 ASSIGN keys *30*  
 assignable insert position (ASSIGN INSERT) *58*  
 assignable insert switch (ASSIGN INS SW) *58*  
 assignable inserts *51*  
 assignable returns *30, 36, 43*  
 assignable sends *30, 37, 43*  
 Assigning *65*  
 assigning  
     channels to busses *30*  
     inputs to channels *38*  
     modules *108*  
     processors to master channels *65*  
 assignment *30, 40*  
     busses in snapshot 00 *103*  
     busses in surround mode *108*  
     modules in surround mode *108*  
 attack time *66–67*  
 auto make-up (dynamics processors) *67*  
 AUTO MON *33*  
 AUTO PUNCH IN/OUT *33*  
 auto punch operations *87*  
 auto-detect (machine control) *81*  
 auto-detection of devices *81*  
 automation *15, 18, 21, 22, 30, 31, 33, 34, 51, 79*  
     control keys and indicators *34*  
     data *95, 99*  
     fader OFF *22*  
     keys *18*  
     memory *22, 23*  
 AUTOMATION UNDO key *31*  
 aux 1 and 2 source (AUX 1-2 SOURCE) *58*  
 aux sends *15, 17, 55, 115*  
     in snapshot 00 *102*  
 aux sends (global) *55*

**B**

balance  
     level CENTER

0dB *21*

stereo linked pair *52*  
 battery check *22*  
 bulk dumps *95*  
 bulk transfer of data from the DM-24 *95*  
 bulk transfer of data to the DM-24 *96*  
 busses *30, 40, 42, 45, 74, 77*  
     surround mode *107, 108*

**C**

card slots *36*  
 cascade *119*  
 cascade card *119*  
 cascade master *25*  
 channel faders *79*  
 channel source (CH SOURCE) *58*  
 channel stereo linking *115*  
 channels *60, 113*  
 channel-to-buss assignments  
     by channel *41*  
     global *40*  
 chase *81*  
 clock *89*  
 clock settings *24*  
 clock source *30, 35, 46, 112, 118*  
 clock sources  
     checking *25*  
 common controls and displays *51*  
 compression insert (COMP INSERT) *58*  
 compressor *41, 43, 50, 53, 58, 63, 64, 64, 66, 67, 68, 77, 104*  
     insert point *50*  
     switch (COMP SW) *58*  
 contrast  
     display *31*  
 control room monitoring *73*  
 control room outputs *73*  
 control room signal selection *73*  
 copying mute settings to faders *70*  
 CR volume control *32*  
 cueing mode *85*  
 cursor follows EQ Band Key (preference) *22*  
 cursor keys *31*

**D**

DA-38 *92*  
 DA-78HR *90*  
 DA-78HR mixer *90*  
 DA-88 *92*  
 DA-98 *91*  
 DA-98HR *89*  
 DA-98HR mixer *90*  
 dial *31*  
 digital audio I/O *125*  
 digital connections *46*  
 digital delay  
     time *58*

- units 59
- digital input format 26
- digital input parameters 26
- digital inputs 35, 35, 35, 36, 36, 39, 39
- digital inputs and outputs 47
- digital outputs 26, 26, 35, 35, 35, 42, 122
  - word length 26
- digital trim and delay (global) 59
- digital trim control 51
- dimming
  - key and indicator 32
  - talkback 76
- direct outputs 37, 40
- display contrast 31
- dither 89
- DTRS control 80, 82, 85, 87, 88
- DTRS recorder 23, 35, 81, 82, 88
  - ABS time 86
  - CHASE 81
  - connections 46
  - ejecting tapes 82
  - machine control 80, 88
  - punch operations 33, 87
  - word sync 25
- DTRS REMOTE CONTROL 35
- dual-wire (definition) 113
- dynamics
  - channels 17–32 64
    - input channels 1–16 63
    - master channels 65
- dynamics controls 50
- dynamics diagram 66
- dynamics meter 50
- dynamics processor 50, 53, 63
  - library entries 104, 116
- dynamics processors
  - trigger source 64
- dynamics screen 53

---

## E

- editing mappings 83
- editing values 14
- effect loop 43, 45
- effect processors 20, 22
  - library entries 103
- effect returns 76
- effect sends 18, 37, 42, 47, 55, 57, 62, 73, 77, 115
- encoders 15, 30
  - as aux send controls 17
  - as EQ frequency controls 16
  - as EQ gain controls 16
  - as pan controls 17
  - as Q controls 16
  - function select key and indicators 30
  - operation mode 20
- ENTER key 32
- entering numbers 31

- EQ 54
  - buss assignments 51
  - in snapshot 00 102
  - library 55
- equalization 15, 16, 22, 30, 41, 50, 51, 52, 54, 105, 106
- equalizer keys 30
- expander 53, 66
- EXT CLOCK indicator 30
- external control 87
- external dynamics processors and effectors 45

---

## F

- fader auto select 21
- fader control 56, 59–60
- fader groups 22, 70, 116
  - in snapshot 00 103
- fader layers 12, 14, 18, 18, 21, 22, 33, 33, 40, 78, 113
- fader level 79
- fader position 51, 79
- fader sensitivity 21
- fader setup 79
- Fader->Meter Follow (option) 22
- faders
  - as controls 14
  - changing values with the faders 14
  - in snapshot 00 102
  - in surround mode 108
- 5.1 surround 107
- FLASH Info. 22
- frame resolution 84
- frame resolution display 84
- frequency range (EQ) 54
- Fs
  - indicators 30
  - see also “sampling frequency”
  - status 25

---

## G

- Gain (EQ) 54
- ganging EQ 52
- gate 53, 63, 66
  - attack time 66
  - decay time 66
  - hold time 66
  - switch 58
- gate/expander 20, 41, 50, 50, 53, 58, 63, 64, 66, 66, 68, 104
- general MIDI parameters 84
- global digital delay 59
- global digital trim 59
- global pan 52
- global screens 12
- GPI 35
- grouping 69, 102, 116
- grouping layers 69, 71, 72

---

**H**

headphones *30, 32*  
 high sampling frequency *25, 25, 26, 112, 114, 121, 121, 122*  
 high-speed (definition) *113*  
 hysteresis (gate) *66*

---

**I**

I/O assignment *36, 50, 114*  
 I/O connections *125*  
 Inplace solo *75*  
 inplace solo *23, 75, 76*  
   defeat *23, 76*  
 INPUT *33*  
 input channels *8*  
 input monitor *89*  
 input options *122*  
 input phase  
   phase *51, 58*  
 input sources *38*  
 input/return assignments *51*  
 inputs and returns *36, 37, 38, 58*  
 insert *29, 29, 30, 37, 43, 45, 50, 51, 58, 64*  
   STEREO OUTPUT *29*  
 insert point *64–65*  
 interface cards *25*  
 internal effectors *36*

---

**J**

JOG/DATA dial *31*

---

**L**

LAYER STATUS keys *33*  
 LCD display  
   display *31*  
 libraries *116*  
 library  
   direct key operation *20*  
   undo/redo *101*  
 LIBRARY + and – (BANK) *30*  
 library banks  
   dynamics processors *104*  
   EQ *105*  
   snapshots *102*  
 library entries *18, 30, 36, 67, 95, 101, 101, 116*  
   protecting snapshot settings *102*  
 library functions *20, 30, 36, 53, 55, 63, 64, 84, 99, 101*  
 library memory *22*  
 library section *30*  
 lineup oscillator *77*  
 linked aux sends *56*  
 linked channels *21, 61*  
 linked dynamics processors *64*  
 linked modules *60*

linking and unlinking modules *60*  
 locate display mode *20*  
 locate keys and indicators *31*  
 locate preroll *85*  
 location  
   manual *87*  
   manual location points *87*  
 location memories *20, 85, 86*  
 location to a location memory *86*

---

**M**

machine control  
   deleting devices from the list *81*  
   keys *18*  
   location *80*  
   mapping memories *82*  
   parameters *83*  
 managing library entries *99*  
 “master” settings *64*  
 master compressors *43*  
 master meters *78*  
 master modules *60*  
 master settings *40*  
 mastering machine *45*  
 meter and fader setup *79*  
 meter unit *48*  
 metering *77*  
 meters *32, 77*  
   ballistics *79*  
 MIC/LINE connections *44*  
 MIDI  
   active sensing *84*  
   bulk data transfer *95, 96*  
   connections *48*  
   control *80, 81, 88*  
   Control Change *96, 97*  
   Control Change messages *96*  
   controllers *93*  
   device enquiry message *81*  
   faders *93*  
   filtering *84*  
   implementation chart *98*  
   machine control *80*  
   merge *35*  
   MTC *35*  
   Program Change *83*  
   RESET (ffh) *84*  
   settings *31*  
   software updates *96*  
   terminals IN, OUT and THRU *35*  
   timecode *24, 80, 81, 84, 84*  
 MIDI IN MTC *24*  
 MODE SELECT (solo) *22, 75*  
 MODULE key *30*  
 module operations *49*  
 module parameters *41*  
 module screens *12*  
 monitor outputs *29*

# Index N - S

monitor outputs (CR (BAL)) 29  
monitoring 73, 107, 115, 115  
    assignments 73  
    monitor selection keys 32  
    mono 61  
    surround patterns 107  
MTC  
    see "MIDI timecode"  
mute and fader groups 51  
mute group 22, 76  
mute groups 69  
    copying to fader groups 71  
MUTE keys 33

---

## N

naming 101  
normalization 51  
number and predefined function keys 31

---

## O

OL/STATUS indicators 20, 33  
OPTION screen 20  
oscillator 77  
out of range clock signals 26  
output assignments 42, 42  
output busses 8, 37  
    in surround modes 107  
output gain 67  
output options 122  
output signals 37

---

## P

P2 connections 48  
pan 61  
    in snapshot 00 102  
    in surround modes 109  
pan control 51  
    surround 109  
patching between input and return 37  
PFL 23, 75, 75, 76  
phantom power 29, 29  
phase switch 51, 58, 61  
PHONES 30, 32  
PODs 13, 31  
    acceleration 13  
power switch 35  
pptions 118  
pre/post settings 56  
preferences 21  
preset library entries 67  
    compressors 104  
    EQ 106  
    gates 105  
Program Change channels 83  
Program Change values 84  
punch keys and indicators 33

---

## R

repeat play (machine control) 87  
return modules 39  
return source 24, 39, 58, 122  
rotary encoders (ring LEDs) 15, 30  
RS-422 35  
    timecode 23

---

## S

sampling frequency 25, 26  
sampling frequency conversion 25, 26, 30, 39, 47  
2ND F. (MOVE) key 30  
SEL keys 33, 49  
selecting a buss pattern 108  
selecting a gate or an expander 63  
selecting a surround mode 107  
selecting devices for control 80  
selecting modules 49  
selecting the control type for the devices 81  
selecting the location point display 85  
serial output 84  
setting and editing titles 101  
SHIFT key and indicator 31  
signal sources 36  
slate 32  
slate settings 77  
slot cards 27, 37  
SMPTE/EBU timecode connections 48  
soft keys 15, 31  
    library 64  
    pull-up menus 15  
solo 22, 75, 76  
    mode select 22, 75  
    outputs 23  
    SOLO control and indicator 32  
    SOLO key 33  
    SOLO level 76  
    SOLO LINK 22, 75  
    SOLO TYPE 23, 75  
SPDIF 26, 36, 39, 47, 73  
STEREO fader 33  
stereo linking  
    in snapshot 00 103  
stereo linking (global) 61  
stereo master outputs 37  
stereo out  
    setup 26  
stereo outputs 29, 45  
STORE key 31  
storing a location memory "on the fly" 86  
studio monitoring 74  
studio monitoring volume 75  
sub channel (surround) 107  
subwoofer ("boom") 110  
surround  
    in snapshot 00 102



panning *109*  
 sub channel *107*  
 surround assignments *108*  
 surround modes *107*  
 surround operations *107*  
 synchronization and control connections *47*  
 system display *20*  
 system-wide options *20*

---

## T

talkback *76*  
 microphone *32*  
 T/B volume control *32*  
 TC generator *89*  
 TC IN *23*  
 TC REC *89*  
 TDIF *25, 26, 35, 36, 37, 42, 46, 118, 121*  
 card *121*  
 connectors *37*  
 interfaces *25*  
 timecode *23, 24, 35, 48, 48, 82*  
 display *20*  
 flywheel *24*  
 flywheel (frames) *24*  
 generator *24*  
 location *86*  
 output *84*  
 titles of library entries *101*  
 TRA *82*  
 TRA Target link *23*  
 track arming *82*  
 transport and automation control *33*  
 transport keys and indicators *33*  
 trim and delay *116*  
 turning dynamics processors on and off *63*  
 turning groups on and off *70–71*  
 turning soloing on and off *76*

2-track input *74*  
 2-TR IN *29*

---

## U

undo/redo  
 library *101*  
 updating the DM-24 *96*  
 updating the system software *96*  
 user interface *12*  
 utility copying *62*

---

## V

varispeed *26, 89*  
 version information *22*  
 viewing a list of location memories *87*  
 viewing the transport mappings *83*

---

## W

word clock  
 see "word sync"  
 word length *26*  
 word sync *30, 34, 112, 119*  
 connections *48*  
 connectors (OUT/THRU, IN) and switch *34*  
 I/O *11*  
 issues *11*  
 master *11, 89*  
 out of range *26*  
 phase *25*  
 setup *24*  
 slave *11*  
 sources *11, 89*  
 varispeed *26*

# TASCAM

TEAC Professional Division

## DM-24

### TEAC CORPORATION

Phone: (0422) 52-5082

3-7-3, Nakacho, Musashino-shi, Tokyo 180-8550, Japan

### TEAC AMERICA, INC.

Phone: (323) 726-0303

7733 Telegraph Road, Montebello, California 90640

### TEAC CANADA LTD.

Phone: 905-890-8008 Facsimile: 905-890-9888

5939 Wallace Street, Mississauga, Ontario L4Z 1Z8, Canada

### TEAC MEXICO, S.A. De C.V

Phone: 5-851-5500

Campesinos No. 184, Colonia Granjes Esmeralda, Delegacion Iztapalapa CP 09810, Mexico DF

### TEAC UK LIMITED

Phone: 01923-819699

5 Marlin House, Croxley Business Park, Watford, Hertfordshire. WD1 8TE, U.K.

### TEAC DEUTSCHLAND GmbH

Phone: 0611-71580

Bahnstrasse 12, 65205 Wiesbaden-Erbenheim, Germany

### TEAC FRANCE S. A.

Phone: 01.42.37.01.02

17 Rue Alexis-de-Tocqueville, CE 005 92182 Antony Cedex, France

### TEAC BELGIUM NV/SA

Phone: 0031-162-510210

Oeverkruid 15, NL-4941 VV Raamsdonksveer, Netherlands

### TEAC NEDERLAND BV

Phone: 0162-510210

Oeverkruid 15, NL-4941 VV Raamsdonksveer, Netherlands

### TEAC AUSTRALIA PTY.,LTD. A.B.N. 80 005 408 462

Phone: (03) 9672-2400 Facsimile: (03)9672-2249

280 William Street, Port Melbourne, Victoria 3000, Australia

### TEAC ITALIANA S.p.A.

Phone: 02-66010500

Via C. Cantù 11, 20092 Cinisello Balsamo, Milano, Italy